

# VT825i & VT825ii / Remote Monitoring Unit

Documentation page: <https://vutlan.atlassian.net/wiki/spaces/DEN/pages/2713911301/VT825i+VT825ii+Data+Center+Monitoring+Unit>

Product page: <https://vutlan.com/devices/162-55-vt825i-remote-monitoring-unit.html>

Brochure: product version 1.2



## Function and purpose

The unit is used for environmental monitoring (e.g. temperature, humidity, voltage, leakage, smoke, airflow). It is also used as an I/O controller (e.g. door control, fans, generator, control panels, UPS, circuit breakers, alarms). Can use up to 1000 different elements - notifications, triggers, timers, logic schemes, sensors, dry contacts. Has built-in Web interface with virtual sensors, logic schemes, different types of notification, and control panels. Has a slot for an LTE modem for an ethernet connection reservation.

Two order options:

VT825i has only x1 power inlet.

VT825ii has x2 power inlets, providing a redundant power supply for A&B power distribution.

## Order options / Dimensions

System	Description
VT825i	x1 230V AC power inlet.
VT825ii	x2 230V AC power inlets, providing a redundant power supply for A&B power distribution.
VT825iDC	x1 230V AC and x1 24-48V DC power inlets.
VT825DC	x1 24-48V DC power inlet.
VT825DCDC	x2 24-48V DC power inlets.

**S  
y  
s  
t  
e  
m** Diagram

V  
T8  
25i

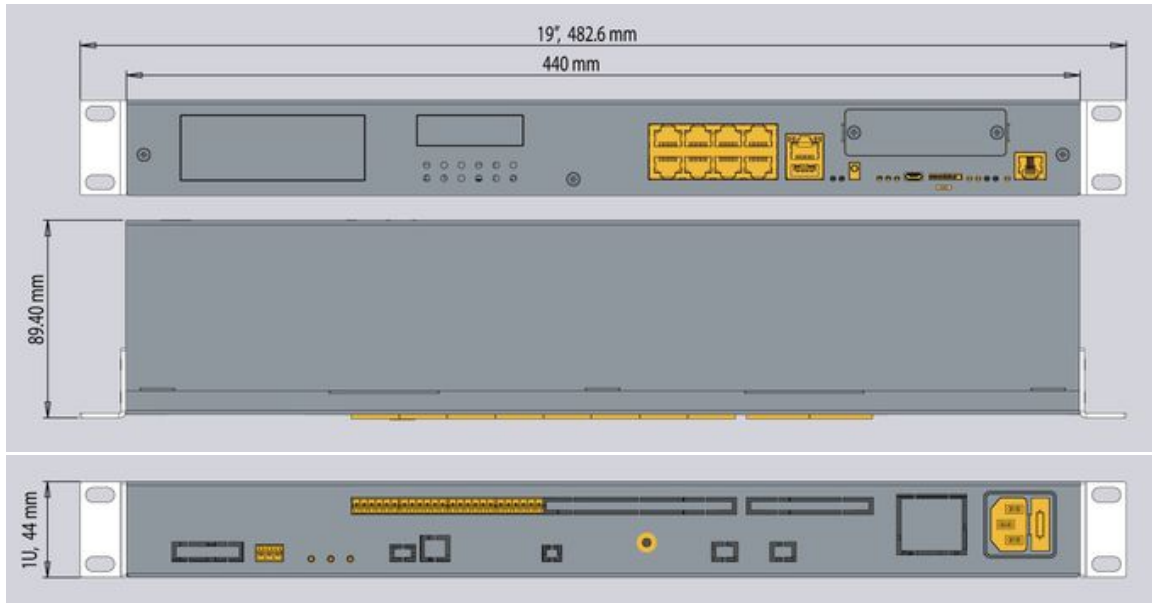

V  
T8  
25  
ii



V  
T8  
25  
iDC



V  
T8  
25  
DC

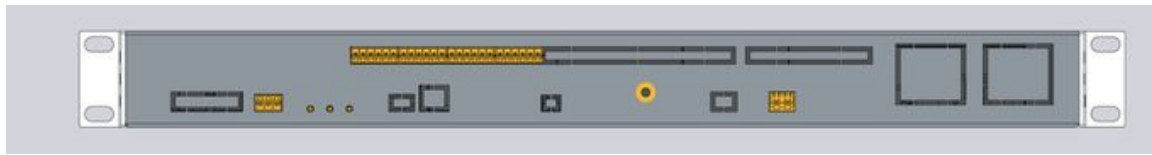

V  
T8  
25  
D  
C  
DC



Physical Description

Front panel:

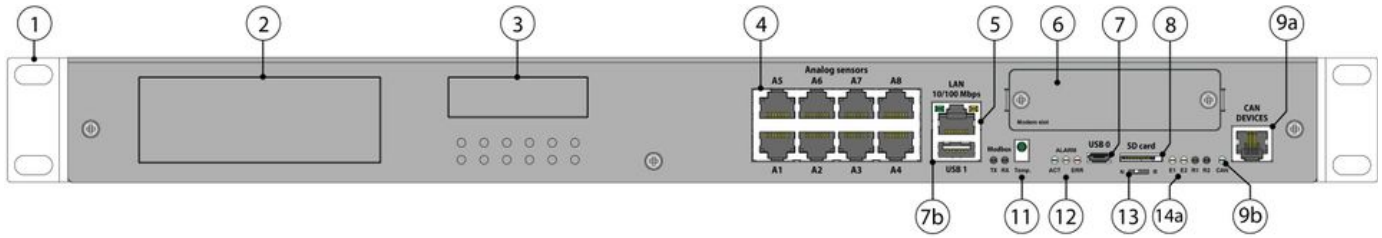

Back panel:

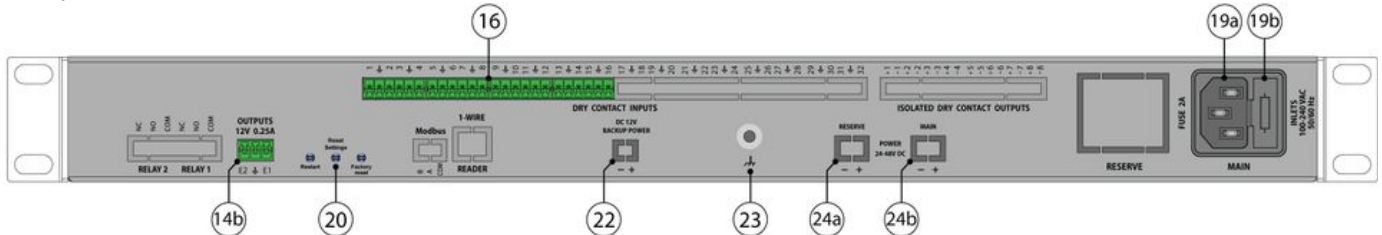

1. "1U 19 inch brackets" - x2 pcs for mounting brackets into a 1U 19" rack slot.
  2. "Logo sticker" - Displays article number of the monitoring unit.
  3. "Sticker space" - A place for a sticker, can be used by a user to place an identifier of the system (for example, an IP address).
  4. "Analog sensors: A1..A8" - 8 RJ12 analog sensor inputs with auto-sensing. Read instructions at "[Analog sensors connection](#)", "[Sensor configuration](#)".
  5. "LAN port" - Ethernet 10/100 Base-T port, provides an Ethernet connection. Read more in this section "[LAN, GSM, LTE, RADIUS, DNS, SSL, VPN](#)".
    - "Orange LED" - orange LED for Ethernet port. It shows network traffic.
    - "Green LED" - green LED for Ethernet port. It shows network traffic. Flashes green when the system starts up. Shows the connection state (constant green light - the connection is established, blinking green - the connection attempt).
  6. "Modem slot" - "VT790 / LTE slot modem" can be installed in this slot. **This modem is ordered separately.** Read instructions at "[VT790 / LTE slot modem](#)", "[LAN, GSM, LTE, RADIUS, DNS, SSL, VPN](#)".
  7. USB ports are needed for USB camera recording, USB Flash for system logs, and for the system restore. Read instructions at "[Connecting USB camera](#)", "[USB camera settings. How to save a video](#)", "[Saving system logs on USB flash drive](#)", "[USB upgrade or restore of default settings](#)".
    - a. "USB 0" - type micro USB-port 2.0, required to connect a USB camera.
    - b. "USB 1" - type USB-port 2.0, required to connect a USB camera or a USB Flash card.
  8. "SD card" - MicroSD card slot with an ejector. The card is needed for data storage or for the "system restore". Read instructions at "[Saving system logs to SD card](#)", "[Restore of the appliance \(for VT960 series\)](#)".
  - 9a. "CAN DEVICES" - digital connector RJ12 for the connection of CAN sensors/extensions/devices on a CAN bus. Modules can be chained together. Read instructions at "[CAN devices connection](#)", "[Setting up CAN](#)".
    - "LED: CAN" - green LED indicates CAN bus status.
    - The LED blinks slowly - nothing is connected
    - The LED blinks fast - configuration is in process
    - The LED glows constantly - connected to CAN devices
  11. "TEMPERATURE SENSOR" - accuracy +/- 1 °C.
  12. "LED: ACT" - green LED indicates appliance system status,
    - - operating mode of the device: switches at a frequency of 2 times per second;
    - - successful completion of the software update process: switches at a frequency of 4 times per second;
- "LED: ALARM" - The button can be programmed from the interface for alarm indicating.
- "LED: ERR" - red LED indicates error and traffic.
- the operating mode of the device: If everything is normal, the LED is extinguished, if not - there's a constant glow;

- software update mode: switches at a rate of 2 times per second;

### 13. "Dip switch"

- Normal mode: The switch is switched to the left . The switch should be always in this position.
- Recovery mode: The switch is switched to the right . Use this option only in case you need to recover manufacturing settings.

### 14a. "OUTPUTS 12V 0.25A" - 12V 0.25A (for each output) terminals outputs (electronic relay). Read instructions at "[Connecting 12V devices to 12V outputs](#)".

- "LEDs: E1, E2" - status indicators for two 12V 0.25A outputs.
- The LED is ON (orange) - the output is ON (the initial state can be configured).
- The LED is OFF (orange) - the output is OFF ((the initial state can be configured).

### 16. "DRY CONTACT INPUTS 1...16" - Digital inputs (Type IN). Read instructions at "[Connecting dry contacts](#)", "[Dry contacts settings](#)".

### 19. Please refer to section "Order options" in this document.

- 18. "RESERVE" - Reserve power inlet. 100-240VAC, 50/60Hz, Fuse 2A, Fuse 5x20mm, type C14.
- 19. "MAIN" - Power inlet. 100-240VAC, 50/60Hz, Fuse 2A, Fuse 5x20mm, type C14.

### 20. Buttons

- 9a. "Restart" - the button restarts the appliance. Hold the button for 2 seconds and then let go, the system will restart.
- 9b. "Reset settings" - reset smoke sensors. Read more at [Operation of smoke detectors in dusty conditions](#).
- 9b. "Factory reset" - reset settings to default factory settings.

### 22. "DC 12V BACKUP POWER" - optional order option. Only available for custom orders.

### 23. "Chassis grounding" - Chassis grounding, M4 thread. Enhances the immunity of the equipment against conducted and radiated RF disturbances. Please contact a professional electrician before connecting it.

### 24. "POWER 24-48V DC" - optional order option for some of the units. Please refer to section "Order options" in this document.

- 24a. "RESERVE" - Reserve power inlet. 24-48V DC, 5.08mm 2EDGK power plug, 18-72VDC to 12VDC/0.84A
- 24b. "MAIN" - Power inlet. 24-48V DC, 5.08mm 2EDGK power plug, 18-72VDC to 12VDC/0.84A

## Connection overview diagram

The front panel of **VT825i & VT825ii**:

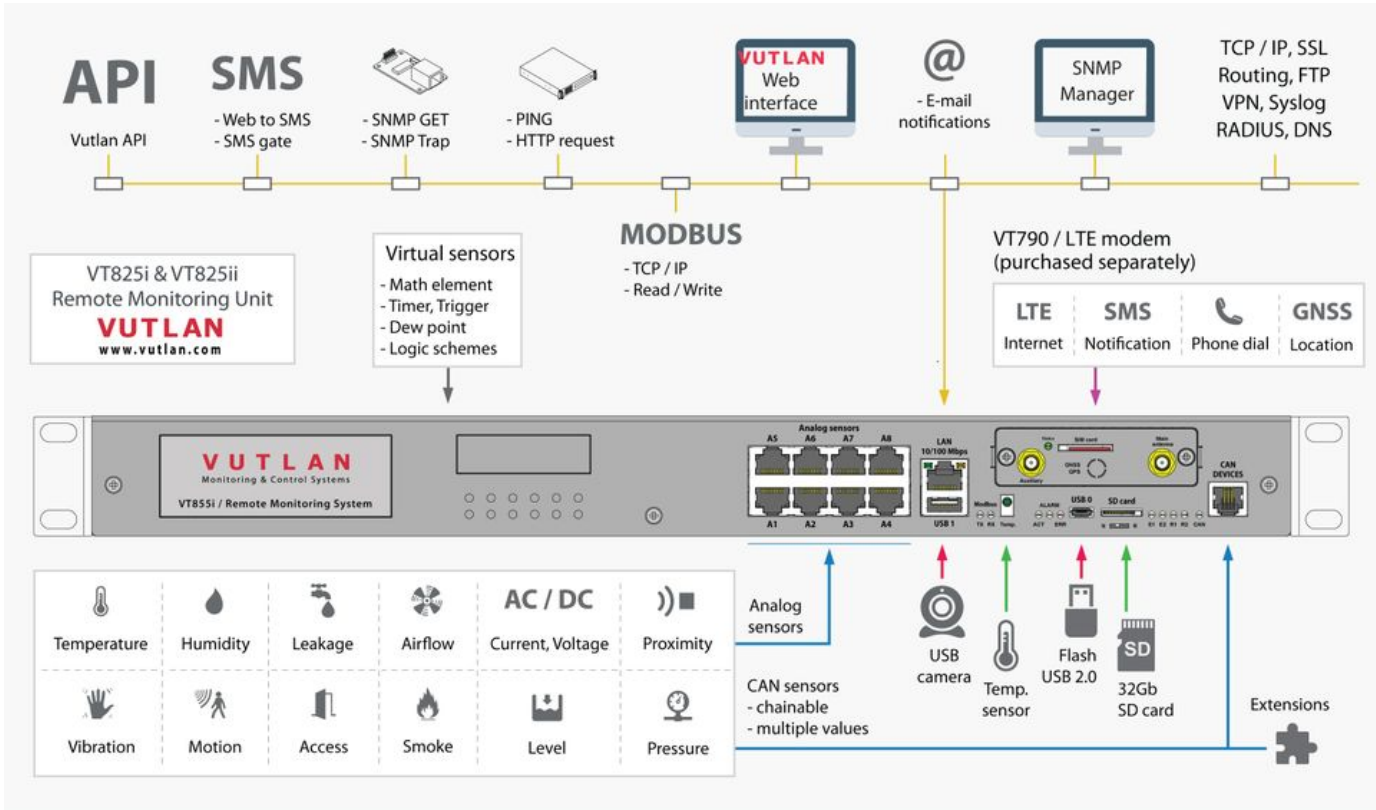

The back panel of VT825ii:

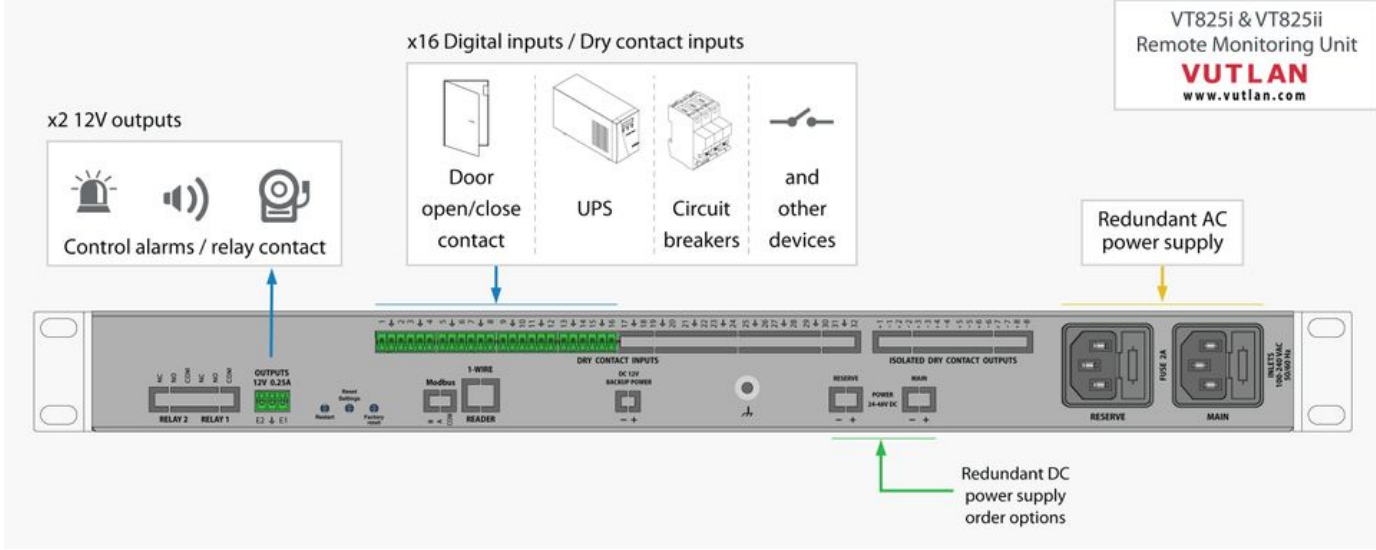

Drawing dimensions

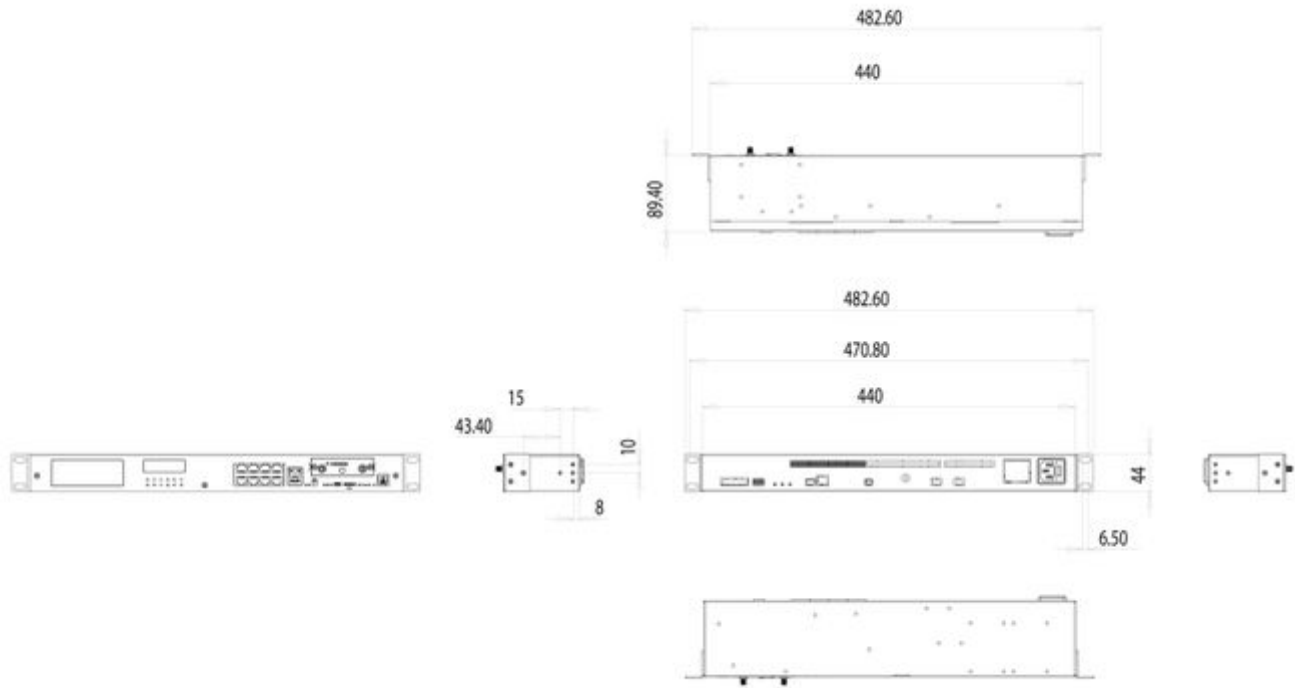

Installing the device into a 19" rack

Use x3 pcs of supplied screws (M3 6mm) for each bracket to fix it on each side of the enclosure as shown in the picture below. The screws and brackets are supplied with the unit.

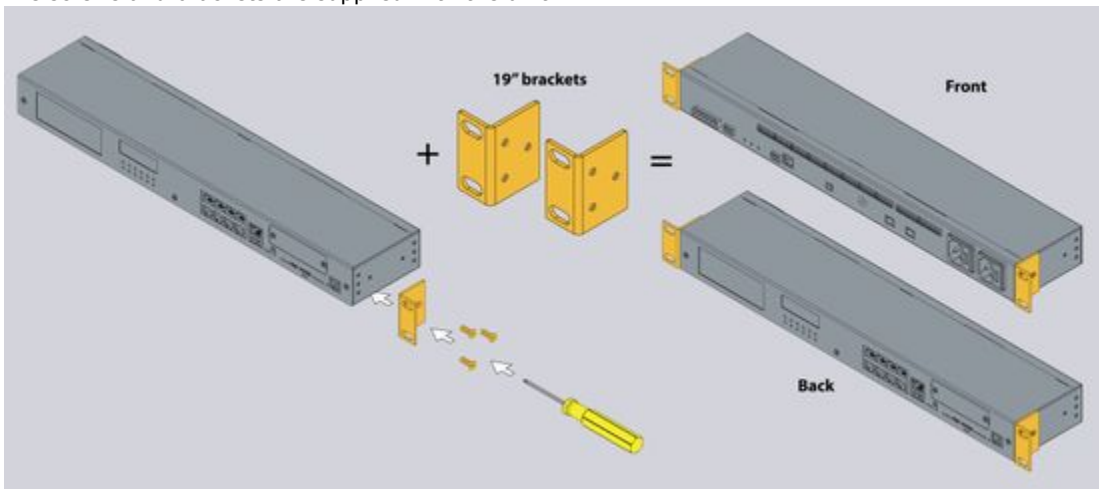

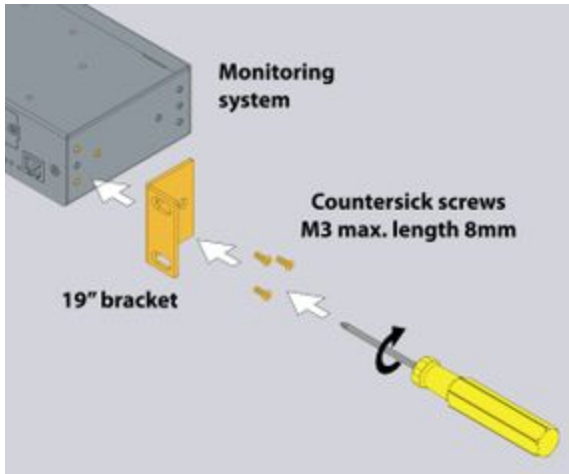

## Installing LTE slot modem

Product page: <https://vutlan.com/modems/155-vt790-lte-slot-modem.html>

Datasheet page: <https://vutlan.atlassian.net/wiki/spaces/DEN/pages/2309947438/VT790+LTE+modem>



## Usage

Can be installed in VT855i v1.2, VT855ii v1.2, VT825i v1.2, VT825ii v1.2, VT960i v2, VT960ii v2 monitoring systems. (These new systems are coming soon).

**i** VT825i v2.6, VT825ii v2.6, VT855i v2.6, VT855ii v2.6, VT960 v3 use VT740 LTE slot modem.

## Description

4G LTE slot modem for Vutlan monitoring units. Allows to receive and send SMS messages. Provides Ethernet over 4G LTE. Power-cycling is an embedded function.

## Panel

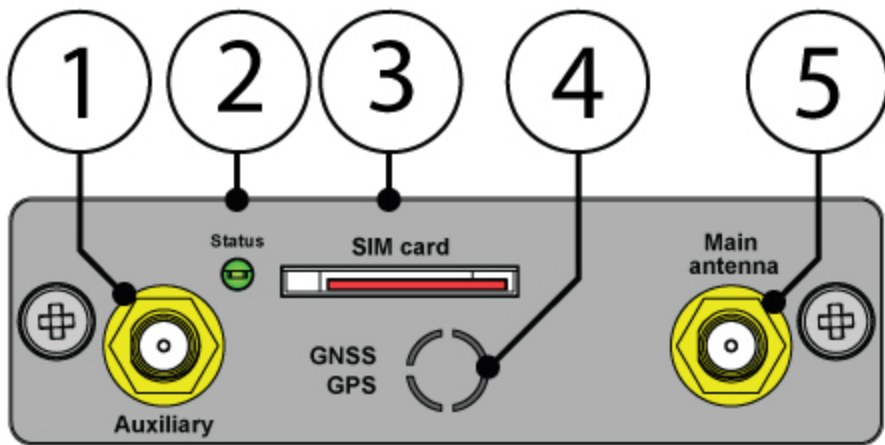

1. "**Auxiliary**" - Connector, used when the modem is installed inside of the appliance to connect LTE auxiliary antenna. The additional antenna helps to strengthen the signal level. (Auxiliary LTE antenna and antenna output are ordered separately from the modem).
2. "**Status**" - displays modems status. Blinking = working.
3. "**SIM card**" - SIM card slot with an injector.
4. "**antenna**" - Connector, used when the modem is installed inside of the appliance to connect GNSS antenna
5. "**Main antenna**" - Connector, used when the modem is installed inside of the appliance to connect GSM or LTE main antenna. (The main antenna is supplied together with the modem).

### Installation

You can install the modem while the system is turned On. You may wait up to 3 minutes until the Telecom operator information is renewed.

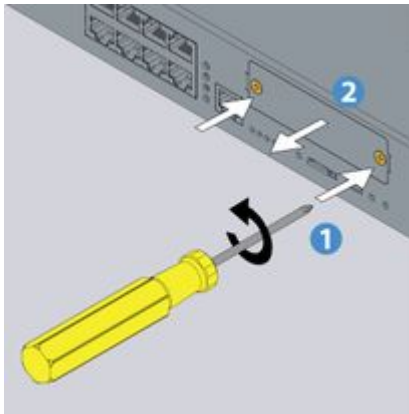

Step 1



1.1 Unscrew the two screws holding the front panel called "**Modem slot**". Keep the screws, you will need them in Step 3.

1.2 Take the panel out and put it away.

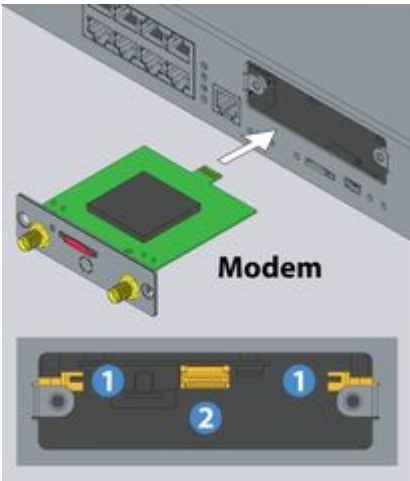
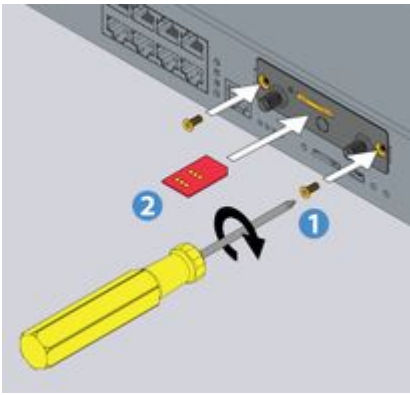
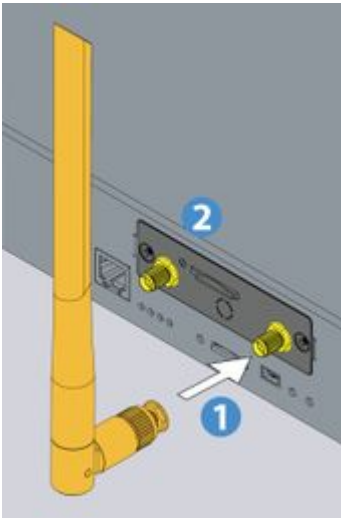

<p>Step 2</p>		<p>Plug the modem as shown on the picture into the opening. The board should slide into the guide rails (marked as "1") and plug into the jack (marked as "2").</p>
<p>Step 3</p>		<p>3.1 Use the screws we unscrewed earlier and screw them in clockwise, securing the new modem in place.</p> <p>3.2 Plug in the SIM card. The SIM card slot has an injector.</p>
<p>Step 4</p>		<p>4.1 Screw the main LTE antenna into "Main" antenna" jack.</p> <p>4.2 If you want to strengthen the signal, you can plug the second auxiliary antenna into "Auxiliary" jack.</p>
<p>Step 5</p>		<p>You are ready to go! Turn on the system.</p>

If you want to unmount the modem, you can unscrew the screws and just pull it out using x2 gold-plated antenna jacks.

Configuring the modem

Please read the following section for the configuration instructions:



Online documentation page link: [Setting up a modem](#)



The direct page link for users with paper documentation:

<https://vutlan.atlassian.net/wiki/spaces/DEN/pages/1016347/Setting+up+a+modem>

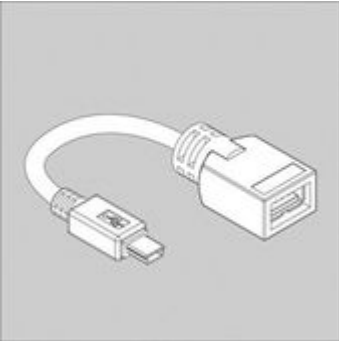
### Inventory

Make sure that the contents of the delivery meet the following configuration. Report a missing or damaged component to your supplier. If damage occurred during transportation, contact the appropriate delivery service.

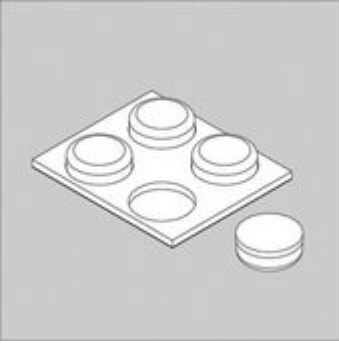
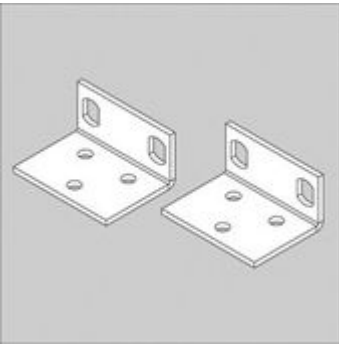
	Package content	Description	Quantity				
			VT825i	VT825ii	VT825iDC	VT825DC	VT825DCDC
1		Monitoring unit VT825i.	1 pc				
2		OTG Micro USB cable adater	1 pc				
3		RJ-45 3m patch cable. For LAN Ethernet connection.	1 pc				

4		Self-adhesive rubber foot	4 pcs
5		19" rack brackets	2 pcs
6		M3 x 8mm Phillips flat-head screws	6 pcs
7		Configuration manual	1 pc

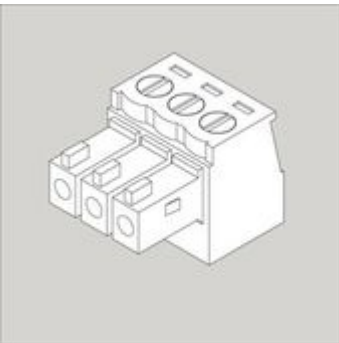
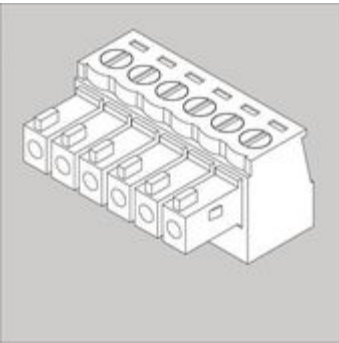
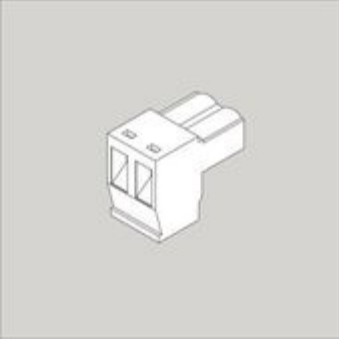
8		Warranty card	1 pc				
9		Terminal plug 3 pins, 3.81 mm. For 12V relays (E1 & E2).	1 pcs				
10		Terminal plug 6 pins, 3.5 mm. For connecting dry contact inputs.	4 pcs				
			VT825I	VT825II	VT825IDC	VT825DC	VT825DCDC
11		Terminal plug 2 pins, 5.08mm, 2P. For power input 24-48VDC.	-	-	1 pc	1 pc	2 pc

12		EU Schuko C13 0.75 mm <sup>2</sup> . 230V 10A cable.	1 pc	2 pc	1 pc	-	-
----	---	--	------	------	------	---	---

## Technical details

VT325, VT335i, VT336, VT825i, VT825ii, VT855i, VT855ii, VT960i, VT960ii are the monitoring units and can not connect to each other. For scalability please use extension units and embedded boards. All units except produced in DC / DC version.

- Built-in
- None
- Extension possible
- ◇ Not extendable

Versions	VT960i / VT960ii DC/DC; AC/DC	VT855i / VT855ii DC/DC; AC/DC	VT825i / VT825ii DC/DC; AC/DC	VT335i	VT336	VT325
<b>Device Management:</b> Web, SNMP, manually via SMS	Yes	Yes	Yes	Yes	Yes	Yes
<b>Interface</b>						
	<b>VT960i</b>	<b>VT855i</b>	<b>VT825i</b>	<b>VT335i</b>	<b>VT336</b>	<b>VT325</b>
<b>LAN:</b> Ethernet 10/100 Mbit	Yes	Yes	Yes	Yes	Yes	Yes
<b>OS:</b> Linux	v.5.10	v.5.40	v.5.40	v.5.40	v.3.10	v.3.10
<b>RAM:</b>	1Gb	128Mb	128Mb	64Mb	64Mb	64Mb
<b>CPU speed:</b>	720mHz	600mHz	600mHz	600mHz	300mHz	300mHz
<b>Clock:</b> Built-in clock	Yes	Yes	Yes	Yes	Yes	Yes
<b>Watchdog:</b> Built-in watchdog timer						
<b>Max. amount of sensors:</b> physical sensors, dry contacts, relays	400	150	150	100	30	6
<b>Max. amount of elements:</b> notifications, triggers, timers, logic, sensors, dry contacts, SNMP Get, SNMP Trap, Dial task and other elements	2000	1000	1000	700	500	500
<b>Protocol support</b>						
	<b>VT960i</b>	<b>VT855i</b>	<b>VT825i</b>	<b>VT335i</b>	<b>VT336</b>	<b>VT325</b>
<b>Network protocols:</b> DHCP; HTTP; HTTPS; DynDNS; SSL/TLS; SNMP v1, v2c, v3; SMTP; FTP; Syslog; RADIUS; Modbus RTU; OpenVPN	Yes	Yes	Yes	Yes	Yes	Yes
<b>VPN:</b> secure data communications; secure change of connection between LTE and LAN	Yes	Yes	Yes	Yes	Yes	Yes
<b>Alerts / Notifications</b>						
	<b>VT960i</b>	<b>VT855i</b>	<b>VT825i</b>	<b>VT335i</b>	<b>VT336</b>	<b>VT325</b>
<b>Alert types:</b> E-mail, FTP log, Syslog, SMTP, SNMP Traps, SMS (Modem is ordered separately), Web-to-SMS,	Yes	Yes	Yes	Yes	Yes	Yes

<b>A maximum number of "mail to" recipients in an E-mail notification:</b>	50	20	20	20	10	10
<b>A maximum number of "SMS to" recipients in an SMS notification:</b> also the maximum amount of phone numbers	50	20	20	20	10	10
<b>Virtual sensors</b>						
	<b>VT960i</b>	<b>VT855i</b>	<b>VT825i</b>	<b>VT335i</b>	<b>VT336</b>	<b>VT325</b>
<b>Pings:</b> Built-in function for server pinging. Test the reach-ability of a host in a network.	Yes	Yes	Yes	Yes	Yes	Yes
<b>IP cameras:</b> Connect the IP MJPEG camera with a proxy via the master module. Only view, no record.	4	4	4	4	4	4
<b>Get SNMP:</b> Read data from external equipment via SNMP PDU GET (v1 /2c)	Yes	Yes	Yes	Yes	Yes	Yes
<b>User keys:</b> Add users who have access using RFID reader.	Yes	Yes	Yes	Yes	Yes	Yes
<b>Logic schemes:</b> Used to specify automatic actions to events that occur in the system.	Yes	Yes	Yes	Yes	Yes	Yes
<b>Timers:</b> Allows you to plan the events in the system.	Yes	Yes	Yes	Yes	Yes	Yes
<b>Triggers:</b> Generate events in the system if logic is triggered.	Yes	Yes	Yes	Yes	Yes	Yes
<b>Push notifications</b>	Yes	Yes	Yes	Yes	Yes	Yes
<b>SNMP traps</b>	Yes	Yes	Yes	Yes	Yes	Yes
<b>Virtual Math element</b> (combine several sensor data and calculate new data)	Yes	Yes	Yes	Yes	Yes	Yes
<b>Logic schemes</b>	Yes	Yes	Yes	Yes	Yes	Yes
<b>Modbus TCP/IP:</b> read / write	Yes	Yes	Yes	Yes	Yes	Yes
<b>Power</b>						
	<b>VT960i</b>	<b>VT855i</b>	<b>VT825i</b>	<b>VT335i</b>	<b>VT336</b>	<b>VT325</b>
<b>Power input:</b>	90-230V	90-230V	90-230V	12V	12V	12V
<b>Power input DC:</b>	24 ÷ 48V	24 ÷ 48V	24 ÷ 48V	12V	□	□
<b>Fuse:</b> Fuse at the inlet	1A	1A	1A	1A	□	□
<b>Max. power consumption:</b>	30W	30W	10W	10W	12W	6W
<b>The maximum current load on the relay:</b>	10A	10A	250mA	250mA	250mA	250mA
<b>Redundant power supply:</b> built-in voltage monitor, voltage range 9-12.6V.	Yes AC/DC DC/DC	Yes AC/DC DC/DC	Yes AC/DC DC/DC	Yes DC 12V	□	□
<b>Outputs</b>						
	<b>VT960i</b>	<b>VT855ii</b>	<b>VT825i</b>	<b>VT335i</b>	<b>VT336</b>	<b>VT325</b>
<b>Relay outputs:</b> latching relays 240V*10A	2	2	□	□	□	□
<b>Relays outputs:</b> 12V 0.25A	2	2	2	2	2	2
<b>Max. dry contact outputs (contact closures/digital outputs)</b>	<b>8</b>	<b>8</b>	□	□	□	□
<b>Audio output:</b> AV OUT	1	□	□	□	□	□

<b>Video output:</b> AV OUT	1	□	□	□	□	□
<b>Inputs</b>						
<b>VT960i</b>	<b>VT855i</b>	<b>VT825i</b>	<b>VT335i</b>	<b>VT336</b>	<b>VT325</b>	
<b>Analog port:</b> 6P6C for connection of any analog sensor.	8	8	8	4	6	2
<b>CAN port:</b> Max number of sensors Use <a href="#">CAN-12V-1A</a> for connecting more than 12 devices.	32	32	32	32	20	□
<b>Dry contact inputs:</b>	32	32	16	4	4	2
<b>Modbus:</b> (Max. 32 sensors, Max. line length 1000m)	1	1	□	□	Yes	Through extension
<b>Reader 1-Wire</b>	1	1	□	□	□	Extension possible
<b>Video</b>						
<b>VT960i</b>	<b>VT855i</b>	<b>VT825i</b>	<b>VT335i</b>	<b>VT336</b>	<b>VT325</b>	
<b>Video cameras:</b>	AV, USB, x4 IP	USB, x1 IP	USB, x1 IP	USB, x1 IP	USB, x1 IP	USB, x1 IP
<b>Video power supply:</b> DC 12V 0,25A for analog camera	Yes	□	□	□	□	□
<b>Other connectors</b>						
<b>VT960i</b>	<b>VT855i</b>	<b>VT825i</b>	<b>VT335i</b>	<b>VT336</b>	<b>VT325</b>	
<b>Ethernet port:</b> 10/100Mbit	Yes	Yes	Yes	Yes	Yes	Yes
<b>USB 2.0 Type A</b>	1	1	1	□	□	□
<b>USB 2.0 micro</b>	1	1	1	1	1	1
<b>Switch Normal / Recovery:</b> returns the device to factory settings	□	□	□	□	Yes	Yes
<b>FEL button:</b> softly restarts SATA drive	Yes	□	□	□	□	□
<b>Shutdown button:</b> Softly shuts down the device.	Yes	□	□	□	□	□
<b>External Memory</b>						
<b>VT960i</b>	<b>VT855i</b>	<b>VT825i</b>	<b>VT335i</b>	<b>VT336</b>	<b>VT325</b>	
<b>SD card slot</b>	Yes	Yes	Yes	Yes	□	□
<b>SATA Drive:</b> 2.5" HDD or SSD (ordered separately)	Yes	◇	◇	◇	◇	◇
<b>Extensions (modules are ordered separately)</b>						
<b>VT960i</b>	<b>VT855i</b>	<b>VT825i</b>	<b>VT335i</b>	<b>VT336</b>	<b>VT325</b>	
<b>SATA:</b> 2.5" HDD or SSD (ordered separately)		◇	◇	◇	◇	◇
<b>Modem (extensions)</b>						
<b>VT960i</b>	<b>VT855i</b>	<b>VT825i</b>	<b>VT335i</b>	<b>VT336</b>	<b>VT325</b>	
<b>4G LTE modem:</b> ordered separately.	VT790	VT790	VT740	VT740	VT770	□
<b>GSM modem:</b> ordered separately	□	□	□	□	□	□
<b>Modem modes:</b> <ul style="list-style-type: none"> <li>Gateway: Internet access</li> <li>Access: Internet access over LTE</li> <li>SMS: SMS notifications</li> </ul>	Gateway / Access / SMS	Gateway / Access / SMS	Gateway / Access / SMS	Gateway / Access / SMS	Access / SMS	SMS (external modem)

Embedded sensors	VT960i	VT855i	VT825i	VT335i	VT336	VT325
<b>Temperature sensor:</b> +/- 1 °C Case temperature.	Yes	Yes	Yes	Yes	Yes	Yes
<b>Power supply voltage sensor:</b> Accuracy (1%)	2	2	2	2	1	1
Environmental characteristics	VT960i	VT855i	VT825i	VT335i	VT336	VT325
<b>Operating temperature:</b> -10 to 80 °C	Yes	Yes	Yes	Yes	Yes	Yes
<b>Storage temperature:</b> -25 to 85 °C	Yes	Yes	Yes	Yes	Yes	Yes
<b>Operating humidity:</b> 0 to 90 %, non-condensing	Yes	Yes	Yes	Yes	Yes	Yes
<b>Storage humidity:</b> 0 to 95 %, non-condensing	Yes	Yes	Yes	Yes	Yes	Yes
Other Features	VT960i	VT855i	VT825i	VT335i	VT336	VT325
<b>Installation:</b>	19" 1U	19" 1U	19" 1U	Desktop	DIN rail	Desktop
<b>Dimensions (L x W x H) in mm:</b>	440*44*120	440*44*90	440*44*90	180*35*80	160*90*58	95*35*80
<b>Weight:</b>	2 kg	1,5 kg	1,5 kg	0,7 kg	0,4 kg	0,4 kg
<b>External chassis grounding:</b> M4 thread	Yes	Yes	Yes	Yes	□	Yes
Web interface (panels)	VT960i	VT960ii	VT855i	VT335i	VT336	VT325
<b>Dashboard panel:</b>	Yes	Yes	Yes	Yes	Yes	Yes
<b>System tree panel:</b> sensors and devices displayed in a hierarchy	Yes	Yes	Yes	Yes	Yes	Yes
<b>Event log panel:</b>	<b>500 logs</b>	<b>300</b>	<b>300</b>	<b>300</b>	<b>200</b>	<b>200</b>
<b>List of latest sent SMS messages:</b>	500	200	200	150	100	100
<b>Supported Vutlan environmental sensors</b>						
Temperature, Outdoor Temperature, Humidity, Water leakage, Wind speed meter, Access sensor, Door sensor, Water Level, AC / DC current meters, AC voltage monitor, Smoke detector, Vibration, Motion / PIR, Converter	Yes	Yes	Yes	Yes	Yes	Yes

- Built-in    □ None    Extension possible    ◇ Not extendable

Copyright:

Vutlan s.r.o. (LLC)

Remote Infrastructure Monitoring and Control



43 ul.Svornosti, 821 06 Bratislava,

Slovak Republic

[www.vutlan.com](http://www.vutlan.com)