



PAPAGO METEO

Measuring temperature, humidity, atmospheric pressure, dew point, CO₂ levels and wind speed and direction
Ethernet and WiFi connectivity
PoE power or external power supply

The screenshot displays the following data for Westray Airport:

Temp+Hum	28.5 °C	46.4 %	15.8 °C
CO ₂	521 ppm		
Runway	SE	0.1 m/s	

Additional details from the screenshot:

- Upper limit: 1000 ppm
- Lower limit: 0 ppm
- Upper limit: 7.0 m/s
- Lower limit: 0.0 m/s

The hardware device is a blue rectangular module with the following text: PAPAGO METEO MEASURING MODULE METEO ETH Meteorological sensor with Ethernet interface from papouch.com. It features an Ethernet port, a USB port, and several screw terminals.

PAPAGO METEO

Datasheet

Created: 02/26/2019

Last update: 01/30/2023 03:04

Number of pages: 40

© 2023 Papouch s.r.o.

Papouch s.r.o.

Address:

**Strasnicka 3164
102 00 Prague 10
Czech Republic**

Phone:

+420 267 314 267

Web:

en.papouch.com

Mail:

info@papouch.com



TABLE OF CONTENTS

Changelog	3	status	23
Getting to know Papago	4	sns	23
Applications	4	Units codes	24
Common Features	4	SNMP	25
Communication Options	5	Objects – variables	25
Properties	5	SNMP objects – general	26
Connection	6	Traps	26
Configuration	8	MODBUS TCP	27
Network	10	Input Register	27
Security	11	SPINEL	28
E-mail	12	Temperature reading	28
SNMP	13	Reading of name and version	30
HTTP GET / MQTT	13	Reading of manufacturing data	30
Sensor Section	18	Automatic message	31
Other Settings	19	Indications	33
Configuration via Telnet protocol	20	Reset	33
Connection	20	Technical parameters	34
IP address is not known	20	Integrated temperature and humidity sensor	34
IP address is known	21	Standalone temperature sensor	36
Telnet main menu	21	Sensor cable	36
Server	21	CO ₂ concentration sensor	37
Factory Defaults	22	Wind speed and direction sensor	37
Exit without save	22	Other parameters	38
Save and exit	22	Default settings of the Ethernet	39
XML	23		

Changelog

Version 9/2022

- Papago METEO ETH version 4.8, Papago METEO WiFi version 2.4
- Added MQTT communication protocol
- Added option for daylight saving time in the southern hemisphere

GETTING TO KNOW PAPAGO

PAPAGO is a family of devices with uniform appearance and communication capabilities. It allows to combine communication interfaces on one side and measuring sensors (inputs) on the other side.

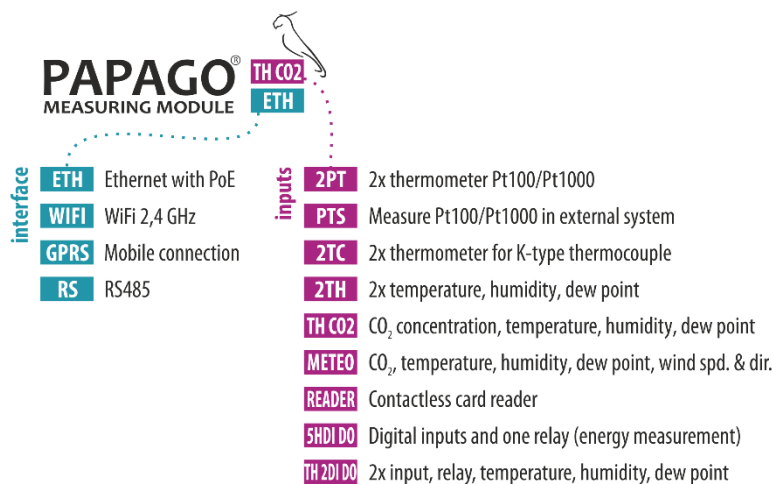

Applications

- Monitoring meteorological values and evaluating them.
- Temperature and humidity, carbon dioxide (CO₂) concentration and wind speed measurement in industry, buildings, and other environments.
- Autonomous industrial meteostation.
- Monitoring temperatures in warehouses and archives.
- Environmental monitoring via the Internet.
- Measurement for the HACCP system.
- Wind speed detection for automatic retraction of outdoor blinds and roller shutters.

Common Features

- Ethernet or WiFi interface to an internal website and many standard communication protocols.
- Ethernet versions with PoE power supply. This eliminates the need to use an external power supply, but the possibility to connect the AC adapter is available.
- Configuration of WiFi parameters via USB interface.
- Internal memory and real-time clock. Measured data including the time of measurement is automatically stored in the memory in the event that communication is lost. The data is automatically sent after the connection is restored.
- Elegant but robust metal box that can be mounted on a DIN rail. The box bears descriptions that allow connection without having to consult the manual. Also LED indicators for all important states help commissioning.
- The possibility to display, store and analyze data in the Wix program.

Communication Options

PAPAGO features different communication options depending on the used interface. PAPAGO can be **controlled by user** via a web interface or via software for Windows. **Machine reading** is possible using various standard methods, so PAPAGO can be easily integrated into your existing systems. You can choose the option that is appropriate for your location:

		automatic control						user control		
		MODBUS	HTTP GET	MQTT	EMAIL	SNMP	XML	SPINEL	WEB	WIX
ETH	TCP	✓	✓	✓	✓	✓	✓	✓	✓	✓
WIFI	TCP	✓	✓	✓	✓	✓	✓	✓	✓	✓
GSM		✓			✓					

Machine data-reading: [Modbus TCP](#), [MQTT](#), [HTTP GET](#) with encryption, [e-mail](#), [SNMP](#), [XML](#), [Spinel](#)

User control: [Web interface](#), Wix software

Properties

Papago METEO can measure temperature, humidity, dew point, atmospheric pressure, carbon dioxide (CO₂) concentration, wind speed and wind direction.

It is possible to connect one of the following sensors to the inputs (only one sensor per input):

TH sensor temperature: -40 to 125 °C; humidity 0 to 100 % inputs: A, B

THP sensor..... atmospheric pressure, temperature: -40 až 125 °C,
humidity: 0 až 100 % inputs: A, B

T sensor..... temperature: -55 to 125 °C inputs: A, B

CO2 sensor carbon dioxide (CO₂) concentration inputs: A, B

Wind sensor ... wind speed and direction inputs: C

- Family of measuring devices with Ethernet or WiFi interface.
- Data reading by user via responsive web interface or Wix software.
- Machine data reading via Modbus TCP, MQTT, HTTP GET, SNMP, XML, email or Spinel protocol.
- The ability to encrypt data in HTTP GET by 128bit AES encryption.
- Measurements via external (1) thermometer or (2) combined temperature and humidity sensor, (3) combined atmospheric pressure, temperature and humidity sensor, (4) CO₂ concentration sensor and (5) wind speed and direction sensor (Sensors are not included.)
- WiFi 2,4 GHz.

- Power supply from PoE (IEEE 802.3af standard; Ethernet versions only) or external source.
- External DC power supply 11 to 58 V.
- Current consumption typically 72 mA at 24 V.

CONNECTION

- 1) Ethernet version: Connect the device by a normal uncrossed cable for computer networks to the switch.
- 2) Ethernet version: If the device cannot be powered by the switch via PoE according to the IEEE 802.3af standard, connect a power adapter to the coaxial connector next to the connector for the Ethernet. DC voltage in the range of 11-58 V is expected. (The positive pole is inside, the input for the power supply has reverse polarity protection.)

WiFi version: Connect a power adapter to the coaxial connector next to antenna. DC voltage in the range of 11-58 V is expected. (The positive pole is inside, the input for the power supply has reverse polarity protection.)

- 3) Connect sensor(s) to connectors A and/or B. Connectors A and B are interchangeable.¹

Anemometer

- 4) Connector C is reserved for the anemometer. When installing it, follow these guidelines:
 - a) It is practically impossible to place the anemometer in such a way that a direct or very close lightning strike is impossible. That also applies to the electronics as well.
 - b) To create the best possible conditions for the anemometer to work properly, it is necessary to place the anemometer to a place exposed to the elements – on a roof, mounting pole or so on. These places are however very prone to lightning damage.
 - c) To minimize the risk of damaging the anemometer, it is necessary to install it in a place protected by a lightning rod and place the [AnemoSP](#) surge protector between Papago and the anemometer.
 - d) [AnemoSP](#) has to be connected as close as possible to the entry point of anemometer cable to the switchboard (< 20 cm) and the grounding terminal.
 - e) Grounding cable must be as short as possible, with cross section at least 6 mm² (10AWG). Use the supplied cable for convenience.
 - f) Maximum allowed cable length is 50cm.
 - g) Place the anemometer cable as far from the lightning conductor.
 - h) We recommend consulting the anemometer placement with lightning protection expert.

¹ The individual types of sensors are available from papouch.com.

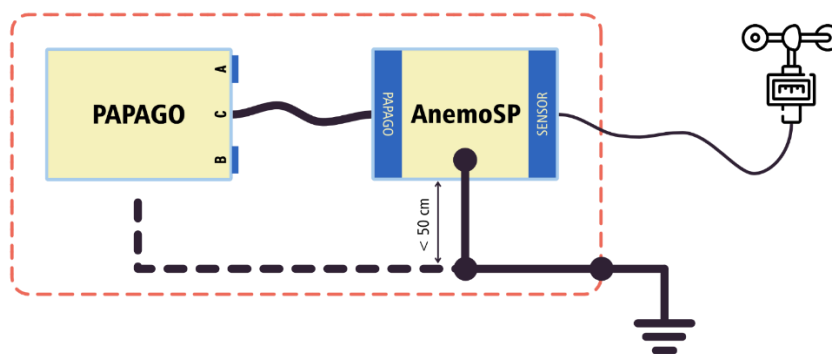

fig. 1 – AnemoSP and Papago connections

- 5) **Ethernet version:** Now it is necessary to set the correct IP address of the device. The default IP address is 192.168.1.254 and network mask 255.255.255.0. If your network is not compatible with this range, set the IP address of the device using [Ethernet Configurator](#).

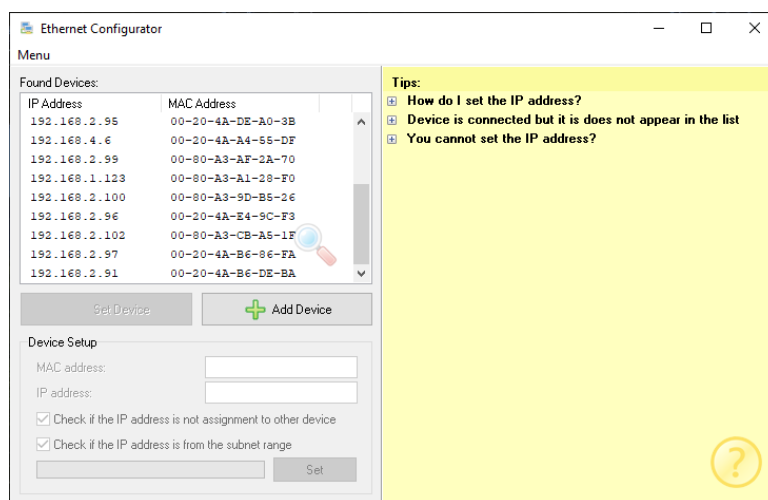

fig. 2 – Ethernet Configurator for setting the IP address

WiFi version: Connect your Papago to a windows PC using the supplied micro USB cable.² Run *Papago WiFi Configurator* software, you can download it on papouch.com. Set-up papago to your WiFi network parameters so you can access it from that network.

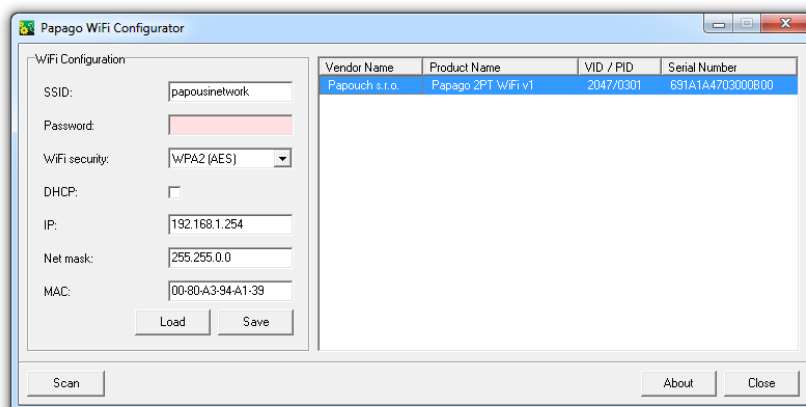

fig. 3 – WiFi configuration via USB

- 6) After setting the address, you can connect to a Web browser at the address specified as follows: <http://192.168.1.254/> (The example is given for the default IP address.)

² In Windows 7 or higher driver will be installed automatically.

CONFIGURATION

Configuration is done via a web interface. The basic network parameters can also be set via Telnet (see page 20). **The web interface** is accessible on the IP address of the device. (The default address is **192.168.1.254**.)

After entering the IP address, the main page will appear showing the latest measured values.

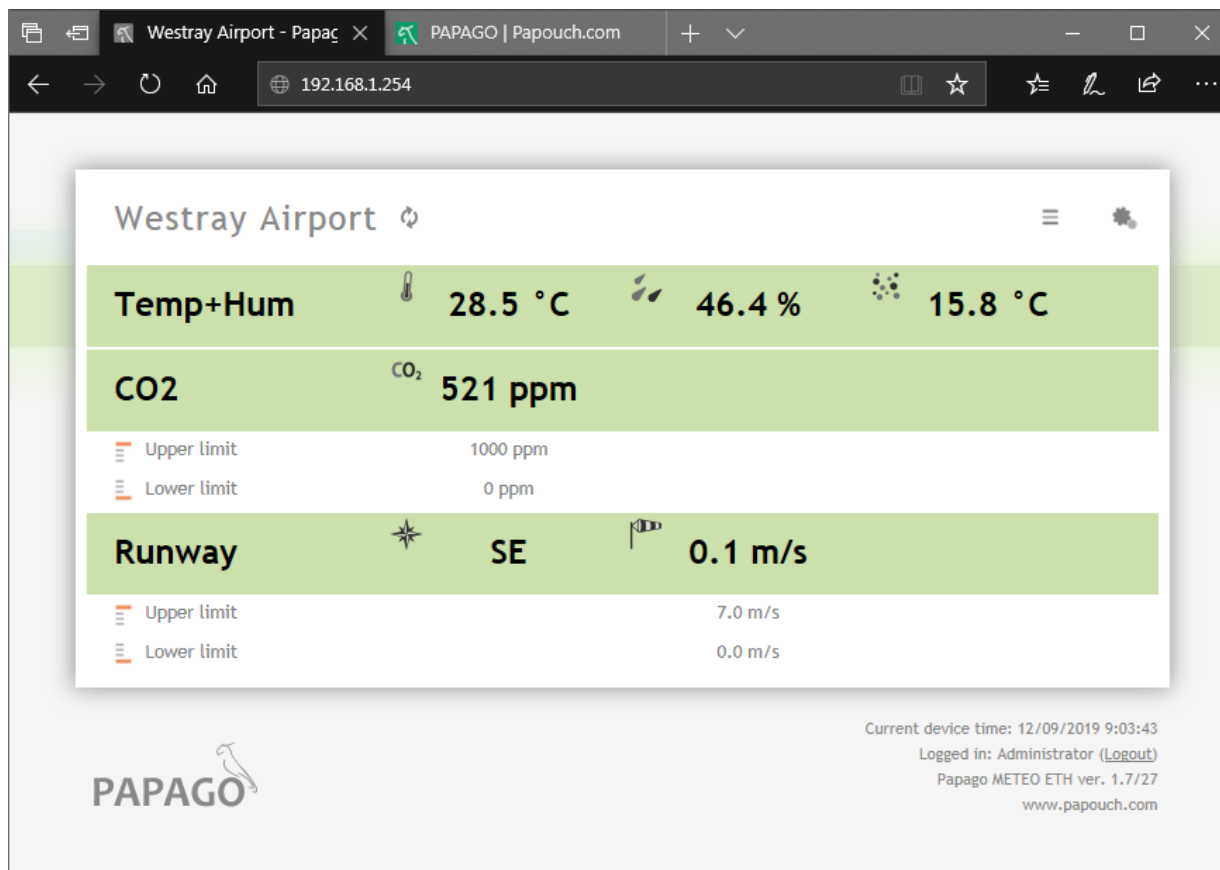

fig. 4 - Example from Papago METEO ETH WEB interface with one temperature-humidity combined sensor, one CO2 concentration sensor and wind speed & direction sensor connected



fig. 5 - sample values from the atmospheric pressure sensor (THP)

The **web interface is secured** with a username and password. You can choose a separate password for the user (who can only display the values on the main page; its login name is always **user**) and for the administrator (who can also change settings; its login name is always **admin**).

The configuration is displayed when you click the icon of gears in the upper right corner. The configuration is divided into sections according to the types of settings and is available in English and Czech.

PAPAGO
from papouch.com

Save
Default
Reload

Homepage
 Network
 Security
 E-mail
 SNMP
 HTTP / MQTT
 Sensor A
 Sensor B
 Sensor C
 Other

Settings

Type:	Papago METEO WIFI	Technical support:	papouch.com
Firmware version:	2.3/37	Phone number:	+420 267 314 268
Serial number:	1423/0039	Signal strength:	-51 dBm
MAC:	00-80-A3-D8-94-E4		
Core version:	Papago METEO WIFI; v1040.01.50; HP C A		
Browser:	Firefox 101		

Network

DHCP

Device's IP address

Netmask

Gateway IP address

DNS server's IP address

WEB port

Miscellaneous

ModBus Port

Data port (Spinel)

WiFi

SSID

Authentication method

Password

Re-enter key

Security

Enter the number of the data port, to on which the device is expecting the TCP or UDP connection. Expected entry: number 1 to 65535.

fig. 6 - Papago configuration with displayed help for data port setting

Network

This section contains the configuration of network parameters.

Network

DHCP	<input type="checkbox"/>
Device's IP address	<input type="text" value="192.168.1.254"/>
Netmask	<input type="text" value="255.255.255.0"/>
Gateway IP address	<input type="text" value="192.168.1.1"/>
DNS server's IP address	<input type="text" value="1.1.1.1"/>
WEB port	<input type="text" value="80"/>

Miscellaneous

ModBus Port	<input type="text" value="502"/>
Data port (Spinel)	<input type="text" value="10001"/>

fig. 7 - network configuration

If the box for assigning addresses via DHCP is ticked, the fields for *Device's IP address*, *Netmask*, *Gateway IP address* and *DNS server's IP address* are reset and upon reloading the settings they are filled again with data obtained from the DHCP server.

If you have a **version with WiFi interface** in the section *Network* is also following parameters:

WiFi

SSID	<input type="text" value="super-secret-password"/>
Authentication method	<input type="text" value="WPA2 (Mixed)"/>
Password	<input type="text" value="Keep original password"/>
Re-enter key	<input type="text"/>

fig. 8 - WiFi network parameters

These options are available as an *Authentication method*: *Open*, *WEP (open)*, *WEP (shared)*, *WPA (TKIP)*, *WPA (AES)*, *WPA2 (TKIP)*, *WPA2 (AES)*, *WPA2 (Mixed)*.

Password length is 8 to 30 characters.³

Security

The section for setting the password of the user (can only access the main page) and the administrator (has access to both the main page and the settings).

Security

User password	<input type="text" value="Keep original password"/>	<input type="checkbox"/>
Confirm user password	<input type="text"/>	
Administrator's password	<input type="text" value="Keep original password"/>	<input type="checkbox"/>
Confirm administrator's password	<input type="text"/>	
Current administrator's password	<input type="text"/>	
Disable Telnet (advanced users only!)		<input type="checkbox"/>
Disable fw upgrade (advanced users only!)		<input type="checkbox"/>

fig. 9 - access security settings

After saving, the passwords are no longer displayed for security reasons. The fields for entering the password show *Not set*, if the password has not been entered, or *Keep original password*, if the password has been entered but is not to be displayed.

The user name is always 'user', the administrator name is always 'admin'. Passwords have a maximum length of 8 characters.³

If user has a password, administrator must also have a password. For security reasons, password is not displayed after saving.

Last two items - *Disable Telnet* and *Disable fw upgrade* - are only available in Ethernet version.

Caution: If you disable Telnet protocol and/or upgrade fw and an error occurs during a firmware upgrade, manufacturer service may be required!

³ Password can contain the following characters:

!#\$%()*+,-./0123456789:;=?@ABCDEFGHIJKLMNOPQRSTUVWXYZ[^_abcdefghijklmnopqrstuvwxy{|}~

E-mail

The device can send e-mails if one of the thresholds set for any of the measuring channels has been exceeded.

E-mail

Send e-mail when a limit is exceeded

To	<input type="text" value="admin@example.com"/>
From	<input type="text" value="iot@example.com"/>
Server address	<input type="text" value="smtp.example.com"/>
Host name	<input type="text"/>
Port	<input type="text" value="587"/>

Security & Authentication

Connection security	<input type="text" value="STARTTLS"/>
Authentication method	<input type="text" value="Password, transmitted securely"/>
User name	<input type="text" value="iot@example.com"/>
User password	<input type="text" value="Keep original password"/>
Re-enter the password	<input type="text"/>

fig. 10 - settings for sending e-mails

Papago METEO ETH cannot communicate with servers that require a secure (SSL/TLS) connection.

User password length is max. 10 characters.³

When the limits are exceeded, the device sends an e-mail – format can be seen below:

Example - when limits are exceeded:

Temperature Sensor A is in range. Value is 27.7 °C.
 Humidity Sensor A is in range. Value is 27.4 %.
 Dewpoint Sensor A is in range. Value is 7.2 °C.
 Temperature Sensor B exceeded upper limit 27.0 °C. Value is 27.5 °C.

Example – upon returning in the range:

Temperature Sensor A is in range. Value is 24.3 °C.
 Humidity Sensor A is in range. Value is 25.1 %.
 Dewpoint Sensor A is in range. Value is 3.1 °C.
 Temperature Sensor B is in range. Value is 24.3 °C.

SNMP

Here you can configure communication via SNMP used for data collection in large networks.

SNMP

Enable SNMP	<input checked="" type="checkbox"/>
Allow trap sending	<input checked="" type="checkbox"/>
SNMP manager's IP address	<input type="text" value="192.168.1.222"/>
Send SNMP trap when the limit is exceeded	<input checked="" type="checkbox"/>
Periodical sending of measured-out values	<input type="text" value="1"/>
Read community name	<input type="text" value="public"/>
Write community name	<input type="text" value="private"/>

fig. 11 - settings for communication via SNMP

For description of SNMP objects see page 23.

HTTP GET / MQTT

Here is settings for sending measured data to remote server – options are *None*, *MQTT* and *HTTP GET*.

HTTP GET

As *Mode* select HTTP GET.

HTTP / MQTT

Mode	<input type="text" value="HTTP GET"/>
Send when limits are exceeded	<input checked="" type="checkbox"/>
Send periodically	<input type="text" value="0"/>
Host	<input type="text" value="iot.example.com"/>
Port number	<input type="text" value="80"/>
Path / Topic	<input type="text" value="scripts/papago/values"/>
GUID	<input type="text" value="21c3dd2a446948b5"/>
Encryption Key	<input type="text" value="Not set"/>
Retype Key	<input type="text"/>

fig. 12 - data sending via HTTP GET

If the sending interval is set to zero, the sending function is turned off. The interval can be set from 0 to 1440 minutes.

If a sensor is set as *Unused*, its parameters are not sent in GET.

If you enter an encryption key of 16 characters (upper- and lower-case letters with no diacritical marks and numbers), the HTTP GET data is encrypted by 128-bit AES cipher (Rijndael), the CFB method.

GET Format

- *Example of periodic GET:*

GET comes from a PAPAGO unit that has one combined and one temperature sensor, one CO₂ sensor and wind speed & direction sensor. & characters are deleted for better readability.

```
script.php?mac=0080A3CA023A type=Papago METEO ETH guid=
description=WATCH index=2 date_time=05/30/2019 15:34:14
CH1_name=Sensor A T1V1_value=27.3 T1V1_units=°C T1V1_status=0
H1V2_value=27.0 H1V2_units=% H1V2_status=0 D1V3_value=6.7
D1V3_units=°C D1V3_status=0
CH2_name=Sensor B C2V1_value=596 C2V1_units=ppm C2V1_status=0
CH3_name=Sensor C A3V1_value=177.4 A3V1_units=° A3V1_status=0
S3V2_value=5.9 S3V2_units=m/s S3V2_status=0
```

- *Example of GET after pressing the button in the settings:*

```
script.php?mac=0080A393A273&type=Papago%20METEO%20ETH
&guid=PAPAGO-TEST-GUID&description=TEST
```

- *Example of encrypted GET⁴ after pressing the button in the settings:*

```
script.php?encrypted_data=%2C%60%32%08%25%03%44%2E%40%29%63%61%34%08%
44%62%67%CF%70%FE%D0%EA%E9%9C%C3%4C%9B%9D%E3%8B%31%18%10%E4%FB%9E%59%
25%56%A4%60%68%1B%77%CC%EE%23%99%D1%CE%1A%AE%B5%E4%BC%D3%0C%84%9E%7C%
F4%2B%5F%B1%D4%99%C6%11%F8%75%C7%E5%27%10%93%DC%8D%43%EF%13%79%37%F1%
D2%5B%35%6B
```

Encrypted part above contains following data: `mac=0080A394A139&type=Papago 2TH WIFI&guid=Papago-GUID&description=TEST`

- *Description of get parameters:*
 - *description*..... Indicates a standard GET with measurement (LOG), GET sent when exceeding a limit (WATCH) or a test GET sent when you press the button on the Web (TEST). GET with measurement and GET sent when exceeding a limit contain the same data
 - *mac* MAC address of the device.
 - *type* Type designation of the device.
 - *guid* Unique user-specified text string.
 - *index* Sequence number of the get request.
 - *log_index*..... Sequence number of the record in a circular buffer.⁵
 - *date_time* Date and time of recording.

⁴ It is 16 bytes of initialization vector followed by encrypted data as specified in the body of standard get. We have examples of get processing for Node.js and PHP in this article on the web (Czech section of website with comments in English): papouch.com/desifrovani-aes-v-http-getu-z-papaga-p3719/

⁵ This number applies if the network connection to the device has been discontinued for some time. After restoring the network connection, all accumulated GETs are sent in the form of a circular buffer. The buffer has a capacity of 120 entries.

- *encrypted_data* This parameter contains the data of encrypted GET.⁴

The following parameters may be given more than once if there are more measured values from one sensor. The first character may be one of following:

- T: temperature
- H: humidity
- D: dew point
- P: atmospheric pressure
- C: CO2 concentration
- A: wind angle
- S: wind speed

Examples of parameters are following:

- *T1V1⁶_value* First temperature as a decimal number.
- *T2V1_value* Second temperature as a decimal number.
- *T1V1_units* Unit of the first measured temperature.
- *T2V1_units* Unit of the second measured temperature.
- *T1V1_status* Status of first value: value is OK (0), upper limit exceeded (2), lower limit exceeded (3) invalid value (4).
- *T2V1_status* Status of second value: value is OK (0), upper limit exceeded (2), lower limit exceeded (3) invalid value (4).
- *CH1_name* Channel 1 name.
- *CH2_name* Channel 2 name.

⁶ The number after the letter T indicates the serial number of the connector on the device. The number after the letter V indicates the serial number of the parameter from the connected sensor.

MQTT

As *Mode*, select MQTT. Papago works as MQTT Publisher. It sends variables from connected sensors to configured broker.

HTTP / MQTT

Mode	MQTT
Send when limits are exceeded	<input checked="" type="checkbox"/>
Send periodically	5
Host	iot.example.com
Port number	80
Path / Topic	sensors/papago/watch
QoS	2
User name	papago
Password	
Retype password	
<input type="button" value="Test message"/>	

fig. 13 - MQTT settings

If **sending period** is set to zero, sending is disabled. Period can be set from 0 to 1440 minutes.

If sensor is set as *Unused*, its parameters are not sent.

Topic enter into field *Path / Topic* (publish topic).

QoS can be selected as 0, 1 or 2.

Security: SSL/TLS security is not supported.

Password: Maximum 15 characters.³

Payload format:

Message example from Papago 2TH with one temperature and one temperature/humidity sensor in JSON format:

```
{
  "dev": "Papago 2TH ETH",
  "mac": "0080A3DC7EF4",
  "loc": "U Papoucha",
  "description": "LOG",
  "log_index": 5,
  "time": "06/29/2020 12:38:00",
  "vals": [{
    "t": "temp",
    "v": 28.3,
    "u": 0,
    "io": 1,
    "e": 0
  }, {
    "t": "temp",
    "v": 27.9,
```



```

    "u": 0,
    "io": 2,
    "e": 0
  }, {
    "t": "hum",
    "v": 49,
    "u": 0,
    "io": 2,
    "e": 0
  }, {
    "t": "dew",
    "v": 16.2,
    "u": 0,
    "io": 2,
    "e": 0
  }
}

```

Parameters description:

- **dev:** Device type
- **mac:** MAC address
- **loc:** Location
- **description:** Event type („LOG“, „WATCH“, „TEST“)
 - LOG: Periodically sent message.
 - WATCH: Right now, set limits have been crossed.
 - TEST: Message sent by button in device configuration.
- **log_index:** Sequence number of periodically sent message. This way you can check continuity of sent messages.
- **time:** Message sending time according to Papago's internal clock.
- **vals:** Array with values from connected sensors. Each element of array contains an object with these values:
 - **t:** value type: temp (temperature), hum (humidity), dew (dew point temperature), pressure (atmospheric pressure), co2 (CO₂ concentration), direction (wind direction), speed (wind speed)
 - **v:** current value
 - **u:** code of physical unit – see Tab 1 on page 24.
 - **io:** connector name from which this variable is read (sensor a = 1, sensor b = 2)
 - **e:** status / error code
 - **0:** everything works
 - **2:** upper limit of measuring range exceeded (overflow)
 - **3:** measured value is less than lower range limit (underflow)
 - **4:** sensor error

Sensor Section

Sensors A and B have their own individual sections with identical settings.

Sensor A

Connected sensor	Temperature / Humidity (TH3x) <input type="button" value="Autodetect"/>
Name	Sensor A
Temperature measurement range	-40 °C to 125 °C
<i>Limit watching</i>	
Watch temperature limits	<input checked="" type="checkbox"/>
Out of limits watching	-4 28
Hysteresis	0
Watch humidity limits	<input checked="" type="checkbox"/>
Out of limits watching	20 48
Hysteresis	0
Watch dew point limits	<input type="checkbox"/>
Out of limits watching	-40 125
Hysteresis	

fig. 14 - temperature and humidity sensor settings

By pressing the *Autodetect* button, all settings for Sensor A and/or B are done automatically according to the currently connected sensor(s), above all the right type of the sensor is entered in the field *Connected sensor*.

If the CO₂ sensor is connected, the available sensor settings change to the following:

Sensor B

Connected sensor	CO2 concentration (T6713) <input type="button" value="Autodetect"/>
Name	Meeting room
<i>Limit watching</i>	
Watch CO2 limits	<input checked="" type="checkbox"/>
CO2 limits	0 1500
Hysteresis	50

fig. 15 – CO₂ concentration sensor setting

Sensor C can only be wind speed and direction sensor. The settings are then following:

Sensor C

Connected sensor	Davis		
Name	Beach breeze		
Display wind direction	As degress		
North direction	Default	0.0°	Set north
Wind Speed Unit	km/h		

Wind speed limits

Out of limits watching	<input checked="" type="checkbox"/>
Limit values	0 100
Hysteresis	5

fig. 16 - sensor C with wind speed and direction settings

Before anemometer installation, please carefully read installation instructions on page 6!

Set north button allows you to manually set the north direction if it is not possible to install sensor exactly in north direction. Install sensor in place, fix the rose in exact north direction and press this button. Detected north direction (offset) is displayed on the right, according to which measurement will be recalculated. *Default* button is used to reset the settings.

Other Settings

This section allows you to set the time, temperature unit, language of the website, etc...

Other settings

Name of the device	Papouch Store		
Language	English		
Temperature units	Fahrenheit [°F]		

Date and time

Synchronize device's time with NTP server	<input checked="" type="checkbox"/>
NTP server's IP address	195.113.144.201
Time zone	(UTC+08:00) Perth
Auto daylight saving	<input checked="" type="checkbox"/>
DST for Southern Hemisphere	<input type="checkbox"/>
Synchronize device's time with this PC's time	<input type="checkbox"/>

fig. 17 - other settings

The available languages are Czech or English; for temperature units you can choose between degrees Celsius, Fahrenheit or Kelvin.

CONFIGURATION VIA TELNET PROTOCOL

Connection

IP address is not known

It is recommended that the IP address should be set using the Ethernet Configurator software (for more information see page 7).

- 1) Open the window of the cmd command. (In the Windows OS select Start/Run, enter `cmd` in the provided line and click Enter.)
- 2) Make the following entries into the ARP table:
 - a. Type `arp -d` and confirm by Enter. This will delete the current ARP table.
 - b. Use the following command to assign 192.168.1.254 to the module MAC address:
`arp -s [new_ip_address] [MAC_address_of_device]`
example: `arp -s 192.168.1.254 00-20-4a-80-65-6e`
- 3) Now open Telnet. (Type in `telnet` and click Enter.⁷)
- 4) Enter `open [new_ip_address] 1` and confirm.
- 5) After a while, the terminal will display an error message saying that connection failed. However, this step is necessary for the module to enter the IP address into its ARP table.
- 6) Connect to the IP address of the module. (Type in `open [IP address in dotted format] 9999` and click Enter.)
- 7) So far you have only entered the configuration mode of the module. The IP address has not yet been set. It must be set in the menu `Server Configuration > IP Address`. If you close the configuration mode without saving the settings and IP address configuration, the whole procedure must be repeated!
- 8) If the entered IP address is valid, the device displays an introductory text ending with:
Press Enter for Setup Mode
Press Enter within 3 seconds, otherwise the configuration mode will close.
- 9) The device will display a preview of its settings.
- 10) The preview ends with a paragraph called "Change setup:" which lists the groups of parameters that can be configured. Network parameters can be changed in the "Server" section where you can set a new network address and other parameters.

⁷ In Windows 10 or higher, Telnet client is not a standard part of system. Install it using following procedure:

- a) Open the "Control Panels/Programs and Features" menu.
- b) On the left, click "Enable or disable features of Windows system" (this option requires the administrator to log in).
- c) The "Features of Windows system" window displays. Here tick the "Telnet service Client" field and click Ok. The client for Telnet will be installed.

IP address is known

- 1) In OS Windows choose Start/Run, enter `telnet` in the provided line and press Enter.⁷
- 2) Connect to the IP address of the module. (Type in `open [IP address in dotted format] 9999` and press Enter.)
- 3) If the entered IP address is valid, the device displays an introductory text ending with:
Press Enter for Setup Mode
Press Enter within 3 seconds, otherwise the configuration mode will close.
- 4) The device will display a preview of its settings.
- 5) The preview ends with a paragraph called "Change setup:" which lists the groups of parameters that can be configured. Network parameters can be changed in the "Server" section.

Telnet main menu

Individual items can be chosen using the numbers written next to them. Choose the required number and press Enter.

The menu structure is as follows:

```
Change Setup:
  0 Server
    ...
  7 Defaults
  8 Exit without save
  9 Save and exit           Your choice ?
```

Server

Basic Ethernet settings.

This section contains the following parameters:

```
IP Address : (192) .(168) .(001) .(122)
Set Gateway IP Address (N) ?
Netmask: Number of Bits for Host Part (0=default) (16)
Change telnet config password (N) ?
```

IP Address*(IP address)*

IP address of the module. The digits must be entered one by one and separated by Enter.

Default value: 192.168.1.254

Set Gateway IP Address*(set the IP address of the gateway)***Gateway IP addr***(IP address of the gateway)*

In "Set Gateway IP Address" enter "Y" to change the IP address. The system then prompts you to change the Gateway IP address. The digits must be entered one by one and separated by Enter.

Netmask*(network mask)*

Here you specify the number of bits of the IP address that make up the network part.

The Netmask is set as a number of bits determining the range of available IP addresses of the local network. If, for example, value 2 is entered, the structure of the Netmask is 255.255.255.252. The entered value specifies the number of bits from the right. The maximum is 32.

Default value: 8

Example:

The mask 255.255.255.0 (binary form: 11111111 11111111 11111111 00000000) = number 8.

The mask 255.255.255.252 (binary form: 11111111 11111111 11111111 11111100) = number 2.

Change telnet config password*(Set the password for Telnet)***Enter new Password***(Enter the password for Telnet)*

This parameter is used to set a new password which is required prior to any configuration via Telnet or via WEB interface (admin password).

For item "Change telnet config password", enter "Y" to change the password. The system then prompts you to change the password.

Factory Defaults

By pressing number 7 the device restores the default settings.

The default setting means that all parameters will return to their initial factory settings. The IP address remains unchanged; the web interface port is set to 80.

Exit without save

To close the configuration mode without saving the changed parameters.

Save and exit

This option saves the changes. If any parameter has been changed, the device is restarted. The restart takes several tens of seconds.

XML

It is possible to obtain the last measured values, limits (thresholds) and device name from the device in the form of a text file in the XML format. The file is available at [http://\[IP-adresa\]/fresh.xml](http://[IP-adresa]/fresh.xml) – i.e. for example at 192.168.1.254/fresh.xml for the default settings.

```
<?xml version="1.0" encoding="iso-8859-2"?>
<root>
  <sns id="1" name="Temp+Hum" type="1" status="0" unit="0" val="28.5" w-min="" w-max=""
      type2="2" status2="0" unit2="0" val2="46.4" w-min2="" w-max2=""
      type3="3" status3="0" unit3="0" val3="15.8" w-min3="" w-max3=""/>
  <sns id="2" name="CO2" type="4" status="0" unit="0" val="521" w-min="0" w-max="1000"/>
  <sns id="3" name="Runway" type="6" status="0" unit="1" val="SE" w-min="" w-max=""
      type2="7" status2="0" unit2="0" val2="0.1" w-min2="0.0" w-max2="7.0"/>
  <status msp="1" level="2" location="NONAME" time="12/09/2019 14:03:43"/>
</root>
```

The XML file contains a *sns* tag for each measured parameter as well as the *status* tag:

status

location

User-defined name of the device.

time

The current system time of the device.

sns

id

The serial number of the measured variable. (The first number is 1.)

name

The name of the sensor.

type, type2, type3

There may be a number 1 (temperature parameters), 2 (humidity parameters), 3 (dew point), 4 (CO₂ concentration), 5 (atmospheric pressure), 6 (wind direction), 7 (wind speed). Attributes with the same index refer to the same quantity.

status, status2, status3

It describes the status of the measured value. Can show the following values:

- 0 the value is valid and shows the currently measured value
- 2 the measured value exceeds the user-set upper limit
- 3 the measured value exceeds the user-set lower limit
- 4 measurement error or sensor error (damaged sensor or cable)

unit, unit2, unit3

Number represents the unit code – see Tab 1 on page 24.

val, val2, val3

The currently measured value as a decimal number, with an accuracy of one- or two-tenths depending on the extent and type of the sensor. (For validity of the value see *status*.)

w-min, w-min2, w-min3, w-max, w-max2, w-max3

The lower (*w-min*) and upper (*w-max*) limit of the value set by the user. The value is shown as a decimal number with an accuracy of one-tenth.

Units codes

The physical quantity unit codes used in [xml](#), [MQTT](#), [SNMP](#), [Modbus](#) and [Spinel](#) are described in the following table. For each variable, the constants are numbered separately from zero.

code	temperature, dew point	humidity	CO ₂	wind speed	wind direction	atm. pressure
0	°C	%	ppm	m/s	° (degree)	hPa
1	°F			km/h	shortcut	
2	K					

Tab 1 – Units codes

SNMP

The SNMP protocol (version 1) contains objects with individual values. For a detailed description of the objects see below. The MIB table you can import into your SNMP manager can be downloaded from papouch.com.

Name	Syntax	Value
deviceName.0	DisplayString	NONAME
psAlarmString.0	DisplayString	(zero-length)
inChType.1	INTEGER	4
inChType.2	INTEGER	4
inChStatus.1	INTEGER	0
inChStatus.2	INTEGER	0
inChValue.1	INTEGER	955
inChValue.2	INTEGER	880
inChUnits.1	INTEGER	0
inChUnits.2	INTEGER	0
index.1	INTEGER	null

fig. 18 - example from Papago TH CO2 ETH

If you need to get all the OID objects with the tool SNMPWALK (Linux), then it is necessary to specify the start OID position, for example:

```
snmpwalk -v1 -c public 192.168.1.254 1.3.6.1.4.1.18248
```

Objects – variables

Type

Name: inChType

Object ID: 1.3.6.1.4.1.18248.31.1.2.1.1.1.1 až 6⁸

Description: The type of this value. It can have one of the following values:

- 0 → Not used.
- 1 → Temperature.
- 2 → Humidity.
- 3 → Dew point.
- 4 → CO₂ concentration.
- 5 → Atmospheric pressure.
- 6 → Wind direction.
- 7 → Wind speed.

Status

Name: inChStatus

Object ID: 1.3.6.1.4.1.18248.31.1.2.1.1.2.1 to 6⁸

Description: The status of this value. It describes the current status of the measured value. It can have one of the following values:

⁸ The ID of the objects shows the values from sensors A and B arranged one after another. First A, then B. The values are arranged in the order of temperature, humidity, dew point, CO₂, wind direction and wind speed.

- 0 → The value is valid and within the limits.
- 1 → The value has not yet been measured.
- 2 → The value is valid and exceeds the upper limit.
- 3 → The value is valid and exceeds the lower limit.
- 4 → The value is invalid – measurement error.

Measured value

Name: inChValue

Object ID: 1.3.6.1.4.1.18248.31.1.2.1.1.3.1 to 6⁸

Description: The measured value as an integer. To obtain the real value, divide by ten.

Unit

Name: inChUnits

Object ID: 1.3.6.1.4.1.18248.31.1.2.1.1.4.1 to 6⁸

Description: Number represents the unit code – see Tab 1 on page 24.

SNMP objects – general

The following two objects relate to the entire device.

Device name

Name: deviceName

Object ID: 1.3.6.1.4.1.18248.31.1.1.1.0

Description: User-defined device name.

Alarm text

Name: psAlarmString

Object ID: 1.3.6.1.4.1.18248.31.1.1.2.0

Description: Text of the alarm message sent when a threshold is exceeded.

Traps

Trap 1 – Value is outside the limits

The trap contains the measured value and the limit that was exceeded.

The trap is only sent when one of the limits has been exceeded. The trap can only be delivered to a properly configured IP address of a PC with the SNMP manager.

Trap 2 – Current measured values

The trap contains all current values as well as the name of the device set by the user.

The trap is sent only if a non-zero frequency of sending has been set.

MODBUS TCP

Input Register

Input Register contains the currently measured data from both sensors in several formats. The records of the sensors and their individual values are identical and are repeated in the memory in the ranges listed below.

Address	Access	Function	Name
Sensor A – head			
0	read	0x04	Status Contains the status of the sensor. Possible values: 0 = this sensor is not used (set to Not Connected in the configuration) 1 = this sensor is used for measuring
1, 2	read	0x04	Date and time Date and time of the device in the format of NTP.
Sensor A – first quantity (depending on sensor)			
10	read	0x04	Status of the measured values Status of the measured values. Options: 0 = the measured value is within the measuring range 2 = exceeded upper limit of the measuring range (overflow) 3 = exceeded lower limit of the measuring range (underflow) 4 = the measured value is invalid
11	read	0x04	Value in the form of signed integer
12	read	0x04	Value in the float format The upper two bytes.
13	read	0x04	Value in the float format The lower two bytes.
14	read	0x04	Unit Number represents the unit code – see Tab 1 on page 24.
Sensor A – second quantity (depending on sensor)			
20 to 24			
Sensor A – third quantity (depending on sensor)			
30 to 34			
Sensor B			
from 100			
Sensor C			
from 200			

SPINEL

The device contains the standard Spinel protocol (format 97) for communication via the TCP data channel. Application development with this protocol is easy due to [Spinel Terminal](#), [Spinel.NET SDK on Github](#) and [Spinel online parser](#).

index	time	data
0	14:05:59.010	2A 61 00 05 31 02 F3 49 0D
1	14:05:59.018	2A 61 00 25 31 02 00 50 61 70 61 67 6F 20 32 50 54 20 45 54 48 3B 20 76 31 30 31 30 2E 30 31 2E 30 31 3B 20 66 39 37 EB 0D
2	14:06:07.369	2A 61 00 06 31 02 58 01 E2 0D
3	14:06:07.378	2A 61 00 1A 31 02 00 01 01 01 80 00 00 FB 41 C9 7C 81 20 20 20 20 20 32 35 2E 31 1C 0D
4	14:06:21.483	2A 61 00 05 31 02 FA 42 0D
5	14:06:21.484	2A 61 00 07 31 02 06 03 F2 3F 0D
6	14:07:14.566	2A 61 00 57 31 04 0F 58 31 31 2F 32 35 2F 32 30 31 34 20 31 34 3A 30 37 3A 33 32 01 01 01 81 00 20 20 20 20 20 20 20 20 B0 43 00 BD 41 97 79 6B 20 20 20 20 20 20 31 38 2E 39 02 01 01 82 00 20 20 20 20 20 20 20 B0 43 0C 95 43 A1 0E 49 20 20 20 20 20 33 32 32 2E 31 63 0D
7	14:07:20.156	TCP/IP client socket - disconnecting
8	14:07:20.166	TCP/IP client socket - disconnect
9	14:19:35.451	device is gone - serial, parallel - COM8

fig. 19 - communication with the device using the Spinel Terminal program

Summary of implemented instructions:

Temperature reading

This instruction reads the current measured values. The values are converted to the currently selected temperature unit. The measured values are returned as a sign integer, as a value in the float format and as an ASCII string.

Request:

Instruction code: 58H

Parameters: (sensor)

sensor	Sensor No.	length: 1 byte
The number of the sensor to be read. It is possible to choose 01H (sensor a) or 02H (sensor b).		

Response:

Acknowledgement code: ACK 00H

Parameters: {(sensor₁)(variable₁)(type₁)(status₁)(unit₁)(unita₁)(value₁)} {...}

sensor	Sensor No.	length: 1 byte
This bytes indicates the sensor number and applies to all subsequent bytes until the next <i>chn</i> byte. This means that the following bytes belong to the channel with that number. It is numbered from 01H.		

variable	Variable No.	length: 1 byte
The number of the variable from the given sensor. Numbered from 01H.		

type	Variable type	length: 1 byte	
The type of the variable can have one of the following values:			
00H not defined	04H CO ₂ concentration
01H temperature	05H atmospheric pressure
02H humidity	06H wind direction
03H dew point	07H wind speed

status	Status of the measured value	length: 1 byte
The status of the measured value for the channel with the number given in the previous <i>chn</i> .		
bit 0 (LSb)	0 = the lower limit of the monitored range was not exceeded	
	1 = the lower limit of the monitored range was exceeded	
bit 1	0 = the upper limit of the monitored range was not exceeded	
	1 = the upper limit of the monitored range was exceeded	
bit 2	0 = the lower limit of the measuring range was not exceeded	
	1 = the lower limit of the measuring range was exceeded	
bit 3	0 = the upper limit of the measuring range was not exceeded	
	1 = the upper limit of the measuring range was exceeded	
bit 7 (MSb)	0 = the measured value is invalid	
	1 = the measured value is valid	

unit	Unit	length: 1 byte
Number represents the unit code – see Tab 1 on page 24.		

unita	Unit in ASCII string	length: 10 bytes
Unit Code as a right-aligned ASCII string. For example °C, °F, etc.		

value	Measured value	length: 16 bytes
The measured value from the channel with the number given in the <i>chn</i> byte.		
The values are sent simultaneously in three different formats. The first is a 16bit sign value (integer in the form of MSB:LSB), followed by two values converted for the current range based on the current setup: in the 32 bit float format according to IEEE 754 ⁹ and in the ASCII format. The values are given in the aforementioned order.		
<i>Example:</i>		
The value of 9215.85 is expressed as follows:		
0AH, 58H, 46H, 0FH, FFH, 66H, 20H, 20H, 20H, 39H, 32H, 31H, 35H, 2EH, 38H, 35H		
INT part: 0AH, 58H (2648)		
IEEE 754 part: 46H, 0FH, FFH, 66H		
ASCII part: 20H, 20H, 20H, 39H, 32H, 31H, 35H, 2EH, 38H, 35H (9215.85)		

Examples:

Request – read channel 1:
2AH, 61H, 00H, 06H, 31H, 02H, 58H, 01H, E2H, 0DH
Response:
2AH, 61H, 00H, 1AH, 31H, 02H, 00H, 01H, 01H, 01H, 80H, 00H, 00H, EEH, 41H, BEH, D6H, C3H, 20H, 20H, 20H, 20H, 20H, 32H, 33H, 2EH, 38H, 93H, 0DH
The value measured on channel 1 was 21,74.
Channel number: 01H
Variable number: 01H
Variable type: 01H
Value status: 80H
Unit: 00H

⁹ The description of the IEEE 754 standard is available here: http://en.wikipedia.org/wiki/IEEE_754

INT part: 00H, EEH (5434)
 IEEE 754 part: 41H, BEH, D6H, C3H
 ASCII part: 20H, 20H, 20H, 20H, 20H, 00H, 32H, 33H, 2EH, 38H (21.74)

Reading of name and version

Reads the name of the device, software version and the list of possible communication formats. Set by the manufacturer.

Request:

Instruction code: F3H

Response:

Acknowledgement code: ACK 00H

Parameters: (string)

string	Name and version	length: 1 byte
	Papago 2PT ETH; v1010.01.01; f97	
In addition to the information described above, the string can also contain other information in sections introduced by a semicolon, space and a small letter to determine which information follows.		

Examples:

Request:
2AH, 61H, 00H, 05H, 31H, 02H, F3H, 49H, 0DH
Response:
2AH, 61H, 00H, 25H, 31H, 02H, 00H, 50H, 61H, 70H, 61H, 67H, 6FH, 20H, 32H, 50H, 54H, 20H, 45H, 54H, 48H, 3BH, 20H, 76H, 31H, 30H, 31H, 30H, 2EH, 30H, 31H, 2EH, 30H, 31H, 3BH, 20H, 66H, 39H, 37H, EBH, 0DH,

Reading of manufacturing data

This instruction reads the manufacturing data of the device.

Request:

Instruction code: FAH

Response:

Acknowledgement code: ACK 00H

Parameters: (product_number)(serial_number)(other)

product_number	length: 2 bytes
Product number. For a device number 0227.00.03/0001 this number is 227.	
serial_number	length: 2 bytes
Serial number. For a device number 0227.00.03/0001 this number is 1.	
other	length: 4 bytes
Other manufacturing information.	

Examples:

Request:
2AH, 61H, 00H, 05H, FEH, 02H, FAH, 75H, 0DH

Automatic message

This response is generated when the preset limits are exceeded or when the measured value exceeds the physical range of the sensor. The message may contain information about one or more channels.

Acknowledgement code: ACK 0FH

Parameters: [event][time] {[sensor][variable][type][status][unit][unitA][value]} {...}

event Number of the event source	length: 1 byte
This byte specifies the event source. It can be used to distinguish the automatic message sent when the limits or measuring range are exceeded from other automated messages from the device. The value of this byte is 30H.	
time time of the event	length: 19 bytes
Time of the event as a string.	
sensor sensor number	length: 1 byte
The serial number of the sensor the following bytes belong to. Numbering starts from 01H.	
variable variable number	length: 1 byte
The serial number of a variable from one sensor, used to distinguishing between different variables obtained from one sensor, if the sensor provides more than one. Numbering starts from 01H.	
type variable type	length: 1 byte
The type of the variable can have one of the following values:	
00Hnot defined	04H CO ₂ concentration
01Htemperature	05H atmospheric pressure
02Hhumidity	06H wind direction
03Hdew point	07H wind speed
status Status of the measured value	length: 1 byte
bits 0 to 3 (lower nibble)	0000 = the measured value is within the measuring range
	0001 = the lower limit of the monitored range was exceeded
	0010 = the upper limit of the monitored range was exceeded
	0100 = the lower limit of the physical range of the A/D converter was exceeded
	1000 = the upper limit of the physical range of the A/D converter was exceeded

bit 7 (MSb)	0 = the measured value is invalid
	1 = the measured value is valid

unit unit ID	length: 1 byte
Number represents the unit code – see Tab 1 on page 24.	

unitA unit as a string	length: 10 bytes
A right-aligned string designating the selected unit. For example, "°C"	

value measured value	length: 16 bytes
The values are sent simultaneously in three different formats. The first is a 16bit sign value (integer in the form of MSB:LSB), followed by two values converted for the current range based on the current setup: in the 32 bit float format according to IEEE 754 ¹⁰ and in the ASCII format. The values are given in the aforementioned order.	
<i>Example:</i> The value of 9215.85 is expressed as follows: 0AH, 58H, 46H, 0FH, FFH, 66H, 20H, 20H, 20H, 39H, 32H, 31H, 35H, 2EH, 38H, 35H INT part: 0AH, 58H (2648) IEEE 754 part: 46H, 0FH, FFH, 66H ASCII part: 20H, 20H, 20H, 39H, 32H, 31H, 35H, 2EH, 38H, 35H (9215.85)	

Example:

Automatic response:
2AH, 61H, 00H, 57H, 31H, 04H, 0FH, 58H, 31H, 31H, 2FH, 32H, 35H, 2FH, 32H, 30H, 31H, 34H, 20H, 31H, 34H, 3AH, 30H, 37H, 3AH, 33H, 32H, 01H, 01H, 01H, 81H, 00H, 20H, 20H, 20H, 20H, 20H, 20H, 20H, 20H, 20H, B0H, 43H, 00H, BDH, 41H, 97H, 79H, 6BH, 20H, 20H, 20H, 20H, 20H, 20H, 31H, 38H, 2EH, 39H, 02H, 01H, 01H, 82H, 00H, 20H, 20H, 20H, 20H, 20H, 20H, 20H, 20H, B0H, 43H, 0CH, 95H, 43H, A1H, 0EH, 49H, 20H, 20H, 20H, 20H, 20H, 33H, 32H, 32H, 2EH, 31H, 63H, 0DH
Automatic information about exceeding the lower limit on channel 1 and the upper limit on channel 2. The meaning of the values sent for channel 1:
Instruction No.: 58H ASCII time: 31H, 31H, 2FH, 32H, 35H, 2FH, 32H, 30H, 31H, 34H, 20H, 31H, 34H, 3AH, 30H, 37H, 3AH, 33H, 32H Channel No.: 01H Variable No.: 01H Variable type: 01H Value status: 81H Units numerically: 00H Units in ASCII: 20H, 20H, 20H, 20H, 20H, 20H, 20H, 20H, B0H, 43H Current value: In the form of INT: 00H, BDH In the form of float: 41H, 97H, 79H, 6BH In the form of ASCII: 20H, 20H, 20H, 20H, 20H, 20H, 31H, 3BH, 2EH, 39H

¹⁰ The description of the IEEE 754 standard is available here: http://en.wikipedia.org/wiki/IEEE_754

INDICATIONS

Two LEDs integrated in the Ethernet connector:

Yellow – LINK: is lit when the device is connected by cable to a switch or PC.

Green – ACT: indicates communication over the Ethernet.

Two LEDs to the left under the Ethernet connector:

Yellow (right): is lit when the connection is established via Spinel or Modbus.

Red-green (left):

- the green light is lit and the red light flashes when the device is working properly and is connected to at least one sensor
- the green and red LEDs are lit when the device works, but is not connected to any sensor
- the red LED is lit to indicate an error

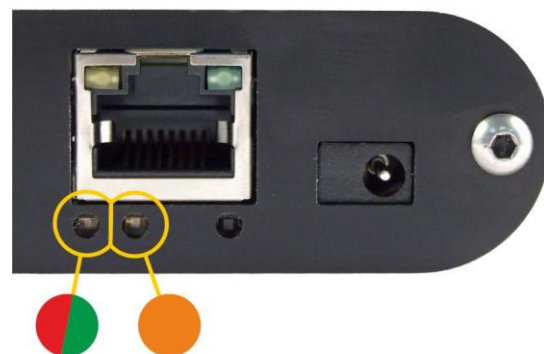

Papago with WiFi connection:

Yellow-blue (right):

- Yellow lights up if Spinel or ModBus connection is established.
- Blue lights up when the Papago is connected to a WiFi network.

Red-Green (left):

- Green lights up and red flashes if the device is OK and at least one sensor is connected.
- Green and Red light up when the device is OK but no sensor is connected.
- Red lights up in case of device fault



RESET

Follow the instructions below to restore the default configuration set by the manufacturer. Unlike when the reset is performed via the web interface or using the Telnet protocol (see page 22), the IP address is also reset to the default value of 192.168.1.254.

- 1) Disconnect the device from the power supply.
- 2) Press the button located in a small hole on the right side under the Ethernet connector.
- 3) Turn on the power and wait for about 10 seconds until the yellow light below the Ethernet connector flashes 4 times.
- 4) Release the button.

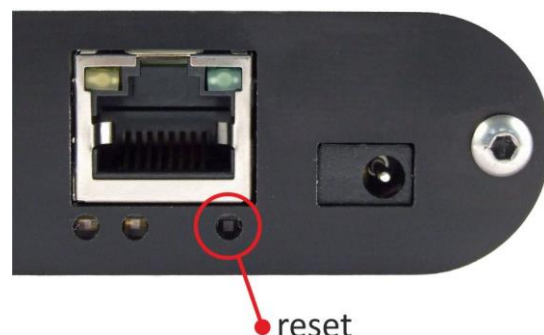

TECHNICAL PARAMETERS

Integrated temperature and humidity sensor¹¹

- TH3: Measures temperature and humidity + calculates dew point
- THP: Measures atmospheric pressure, temperature and humidity

Important Notice: Polymer sensor is a highly sensitive element that reacts with chemicals. Do not expose even the outer shell of the sensor to chemicals or their vapours (cleaning with alcohol, petrol etc.). Especially organic solvents and compounds can negatively affect the sensor accuracy by as tens of percent RH.

Coverage IP 54
 Dimensions 40 × 16 × 10 mm
 Material hardened aluminum

Humidity sensor

Humidity range 0 % to 100 % RH
 Recommended measurement range 20 – 80 %
 Resolution 1% RH
 Humidity measurement accuracy see Fig. 20
 Sensor element polymer sensor
 Sensor mechanical finish inside hardened aluminum block

¹¹ Sensor marked TH3 is supported in firmware including and above version 1.12. If you have an older firmware, you will have to flash the firmware to be able to read from TH3 sensor. Here are the key differences between the old version (Marked as TH2E) and TH3 version:

	TH3 (new sensor)	TH2E (old sensor)
Measurement accuracy within 0 – 10 %	±2 %	±2 to ±4 %
Measurement accuracy within 90 – 100 %	±2 %	±2 to ±4 %
Recommended measurement range	20 – 80 % RH	
Temperature measurement range	-40.0 °C to +125.0 °C	-40.0 °C to +123.8 °C
Temperature measurement accuracy	±0.3 to ±0.5 °C	±0.4 to ±2.0 °C

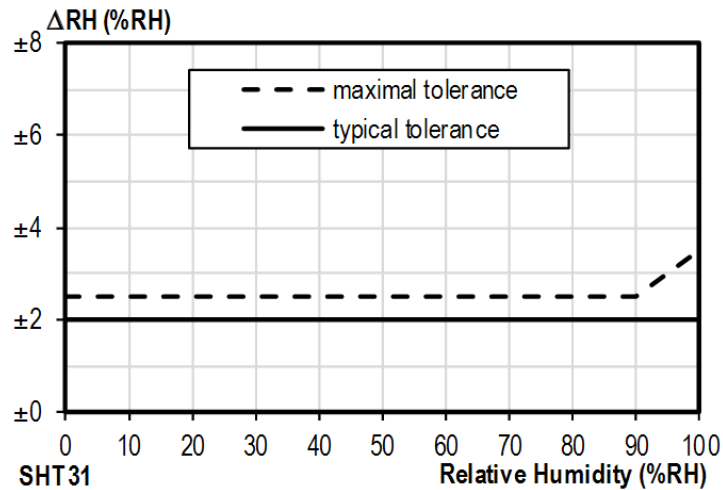

Fig. 20 – Accuracy of humidity measuring

Operating and Maximum Range of Values

- Sensor is stable in standard range of humidity values. Long-term exposure to conditions outside these values (humidity above 80% in particular) can temporarily shift the measured-out values (by +3% for 60 hours). When the sensor is back to standard ranges, it returns to its pre-calibrated state slowly.¹²
- Long-term exposure to extreme conditions or to chemically aggressive vapor can speed up the aging process of the sensor significantly. It can also shift the measurements.

Temperature sensor

Range.....-40.0 °C to +125 °C
 Resolution.....0.1 °C
 Sensor elementsemiconductor
 Sensor mechanical finish.....inside hardened aluminum block

¹² You can speed up this process by doing following:

- 1) Leave the sensor in environment above 100 to 105 °C and humidity below 5 % for at least 10 hours.
- 2) Leave the sensor in environment above 20 to 30 °C and humidity approximately 75 % for around 12 hours. (Humidity 75% can be achieved with saturated solution of NaCl.)

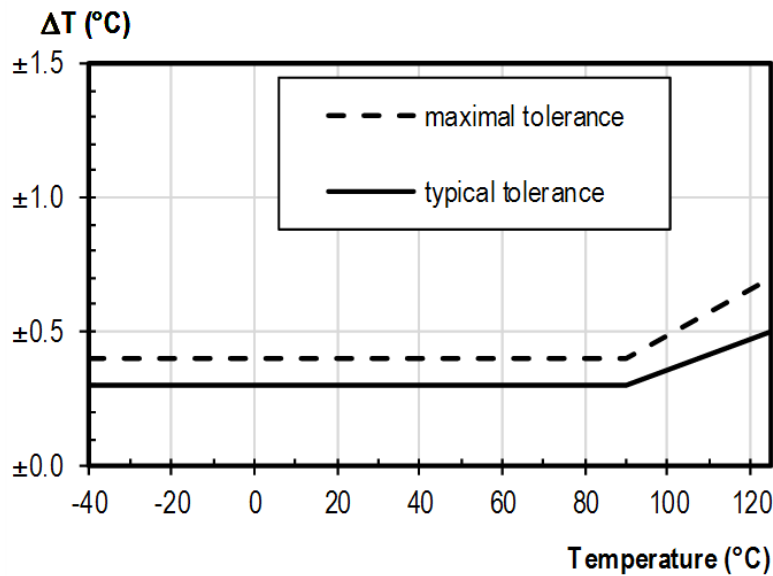

Fig. 21 – Accuracy of temperature measurement

Atmospheric pressure sensor (THP only)

- Measured pressure range 50 to 110 kPa
- Accuracy ±0,4 kPa
- Sensor element semiconductor
- Sensor mechanical finish inside hardened aluminum block

Standalone temperature sensor

- Sensor type semiconductor
- Measuring temperature range -55 °C to +125 °C
- Accuracy ±0.5 °C in the range of -10 °C to +85 °C
- Temperature drift ±0.2 °C per 1000 hours at 125 °C
- Dimensions normalized diameter 6 mm, length 60 mm
- Housing material hardened alloy
- Degree of protection IP68 (permanent immersion into 1m max.)

Sensor cable

- Cable jacket silicone rubber, blue
- Wire insulation FEP polymer
- Length standard 3 m (optionally up to 20 meters)
- Measuring temperature range -60 °C to +200 °C
- Maximum allowable temperature +220 °C
- Cable diameter 4.3 mm (±0.1 mm)

The cable shows excellent resistance to moisture, chemicals and carbohydrates.

CO₂ concentration sensor

Measuring range.....	0 to 2000 ppm ¹³
Measuring method.....	NDIR (nondispersive infrared sensor)
Accuracy within 400 - 2000 ppm	± 25 ppm, ± 3% measured value
Temperature dependency	5 ppm per °C or 0.5% of the value per °C (always the greater value)
Concentration change settling time	max. 3 min to 90 %
Power on settling time	max. 10 minut to 100 %
Sensor operating temperatures	-10 to +60 °C

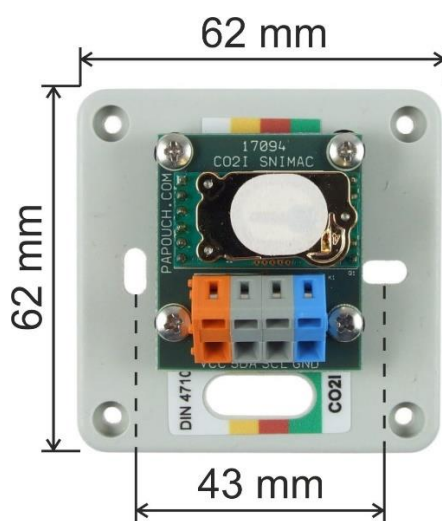

fig. 22 – sensor dimensions

Dimensions.....	see figure above, enclosure height 29 mm
Mounting holes diameter	4 mm
Wire connections	Wago 236 terminal
IP coverage	IP 20
Cable length	3 m, 10 m or custom length

Wind speed and direction sensor

Before anemometer installation, please carefully read installation instructions on page 6!

Type.....	Davis 6410
Operating temperatures.....	-40 to +65 °C
Wind direction resolution	16 steps (22,5°)
Wind direction accuracy.....	±3°
Wind speed measurement range	0.5 to 89 m/s
Wind speed accuracy	±1 m/s or ±5 % (always the greater value)
Wind sensor cable length.....	12,2 m (can be extended)

¹³ If the sensor is in an environment below 400 ppm for longer than 15 minutes, its accuracy can be affected.



fig. 23 – wind speed and direction sensor

Other parameters

Ethernet interface

Connection.....	TBase 10/100 Ethernet
Connector	RJ45
Http get encryption.....	128 bit AES; Rijndael; CFB method
SNMP protocol.....	v. 1
MQTT protocol.....	v. 3.1.1

WiFi interface

Type.....	IEEE 802.11 b/g and IEEE 802.11n (single stream), IEEE 802.11 d/h/i/j/k/w/r
Operating frequency.....	2,4 GHz
Antenna connector.....	SMA RP

Clock circuit and internal memory

Clock backup method (RTC).....	capacitor (not replaceable by the user)
RTC backup time after power outage.....	5 days (if the device was previously connected to a power source for at least three hours without interruption)

Device electronics

PoE power supply	according to IEEE 802.3af
Power supply from an external source	11 to 58 V DC (with reverse polarity protection)
Current consumption from ext. source at 15 V... typically	120 mA
Current consumption from ext. source at 24 V... typically	72 mA
Current consumption from PoE.....	typically 32 mA
Consumption.....	typically 1.8 W
Power supply connector.....	coaxial 3.8 × 1.3 mm; + inside

Operating temperature range	-20 to +70 °C
Dimensions (without connectors).....	88 × 70 × 25 mm
Housing material.....	anodized aluminium
Degree of protection	IP 30
Weight	typically 130 g
Mountable on 35 mm DIN rail	optional accessory

Default settings of the Ethernet

IP address	192.168.1.254
Netmask	255.255.255.0 (8 bits; mask C)
IP address of the gateway	0.0.0.0



fig. 24 – Papago METEO ETH with DIN rail holder

Do not hesitate to contact us if you have any other requirements concerning the design and functions of PAPAGO METEO.

Papouch s.r.o.

Industrial data transmission, line and protocol converters, RS232, RS485, RS422, USB, Bluetooth, Ethernet, LTE, WiFi, measurement modules, smart temperature sensors, I/O modules, custom development and manufacturing.

Address:

**Strasnicka 3164
102 00 Prague 10
Czech Republic**

Phone:

+420 267 314 267

Web:

en.papouch.com

Mail:

info@papouch.com

