

CAN-12V-1A / CAN Power Supply

Documentation page: <https://vutlan.atlassian.net/wiki/spaces/DEN/pages/1904279553/CAN-12V-1A+CAN+Power+Supply>

Product page:



CAN-12V-1A / CAN POWER SUPPLY

Function and purpose

Increases the number of CAN sensors connected on a CAN bus chain. Supplies power for a maximum of 15 additional sensors. Needed only if the number of sensors in a CAN bus chain is greater than 12 sensors.

Technical specifications

Communications	Description
Type	Power supply for CAN bus chain
Input	RJ11 6P4C CAN port 3.4/1,35 mm 12V
Output	RJ11 6P4C CAN port
Daisy chain	Allows daisy chain
Max. q-ty of CAN sensors powered:	15
LED indicators:	Green (Status On/Off)
Environmental	
Working temperature range:	-40 °C до +100 °C
Humidity operating range:	0-95% RH
Power Requirement	
Power input:	12V DC, min. 1A, max.2A
Mechanics	
Dimensions:	68 x 67 x 26,2 mm (LxWxH)
Packaging weight:	190 g

Mounting options:	Desktop, Wall mount, Indoor
General	
Manufactured in:	Slovak Republic, European Union
Manufactured by:	Vutlan s.r.o.
HS code:	8504 40 90
Warranty:	90 days

Physical description

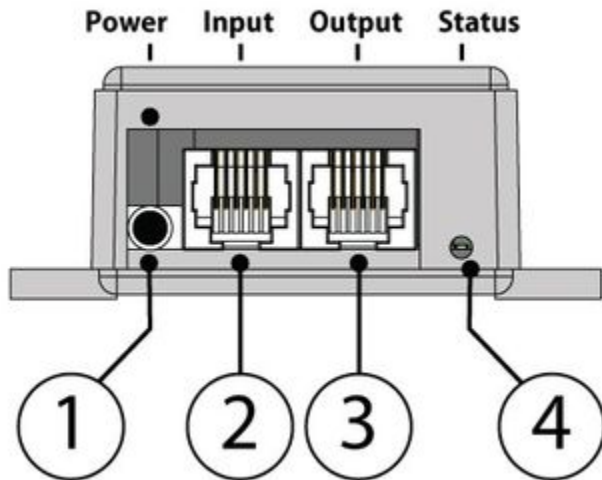

4. LED: "**Status**" (**green**) - indicates that the appliance is connected and operating.
2. "**Power 12V DC**" - power input.
3. "**INPUT**" - This port should be connected to a group of sensors towards the main monitoring unit.
4. "**OUTPUT**" - This port should be connected to a group of sensors further away from the monitoring unit.

⊗ Please, read carefully the instructions about connecting the unit. Connecting CAN sensors to the wrong CAN port on this device may burn the CAN bus line.

Drawings



VT490 v14.2 DWGs.pdf

Connecting the device

- ⊗ It is important that you read this article to the end before connecting the device. Connecting CAN sensors to the wrong CAN port on CAN-12V-1A may burn the CAN bus line.

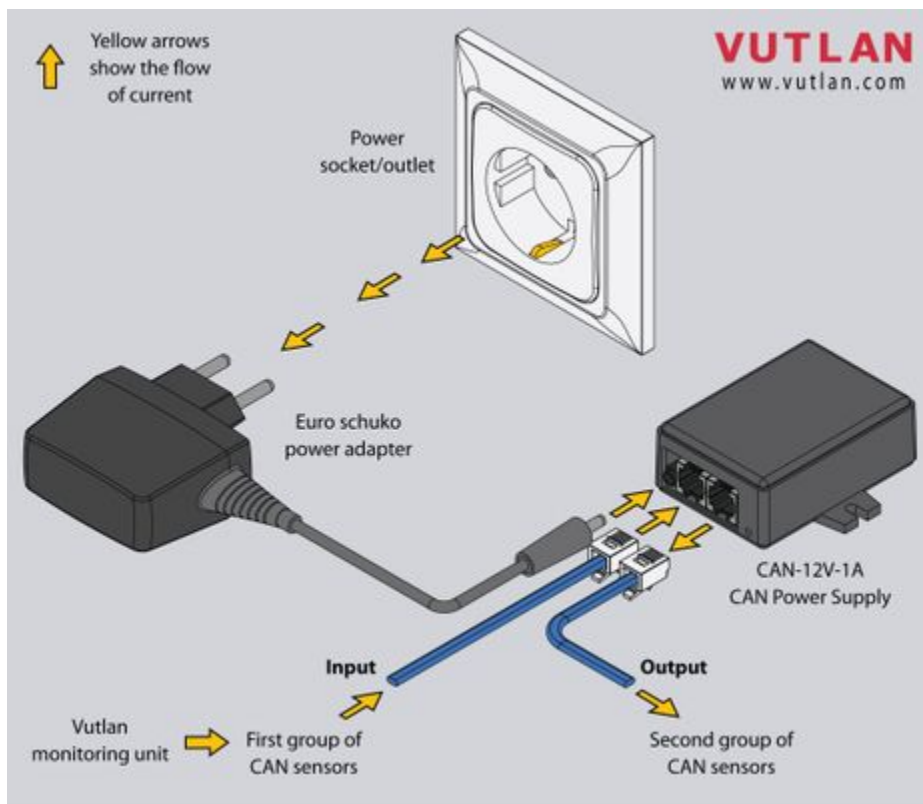

Description:

In our example, we have a monitoring system with a group of sensors (group 1) connected to it. CAN-12V-1A is only needed if we want to connect to the monitoring unit with more than 15 sensors.

Step 1:

- Plug CAN-12V-1A into the power supply socket using a Euro schuko power adapter. The status LED should light **GREEN**.

- Plug all additional sensors (group 2) into the "OUTPUT" port of CAN-12V-1A power supply unit. Group 2 should have no more than 15 sensors connected in a chain.
- All sensors should light **ON**. If some of the sensors do not switch **ON**, decrease the number of sensors connected to CAN-12V-1A, and check the status of each sensor again. If successful, continue to the next step.

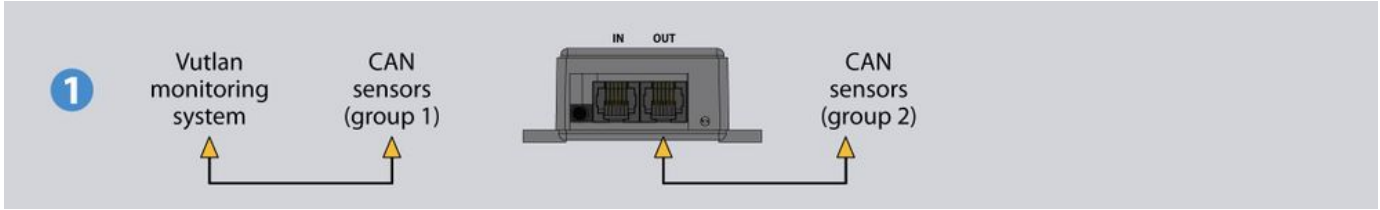

Step 2:

- Connect **GROUP1's** the last sensor to the **INPUT** port of CAN-12V-1A module.
- Switch the last sensors **TR button** to **OFF** position in **GROUP1**. Switch the last sensors **TR button** to **ON** position in **GROUP2**.
- You can now **CONFIGURE** the CAN bus in the web interface. See the "**CAN Configuration**" step below.

If you want to add more sensors, you will need to add an additional CAN-12V-1A module in a chain. The steps are identical for Step1 and Step2.

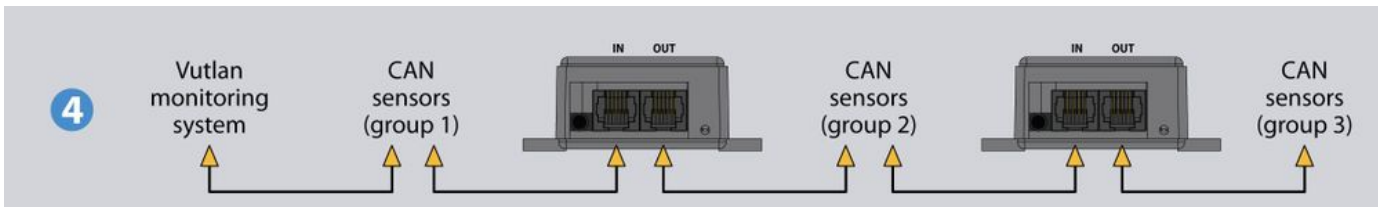
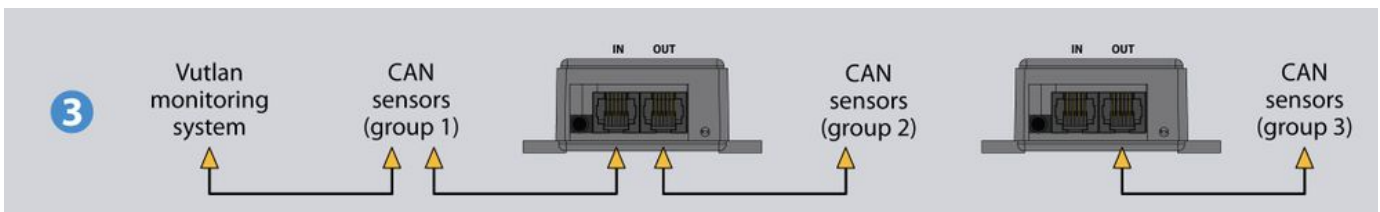

Connecting CAN devices

CAN sensors and CAN units connection

1. Connect CAN devices to any port CAN1 or CAN2 on the monitoring system using a cable supplied. CAN sensors can also be connected to the port of another CAN sensor or CAN unit which is connected on the CAN bus. Determination of the devices and their connection is done through web-interface.

i You can connect up to a maximum of 8 CAN sensors and CAN devices together on one CAN bus (approximately) !

2. The TR should be "ON" for the last sensor on each bus "CAN 1" and "CAN 2". See section "TR" below.

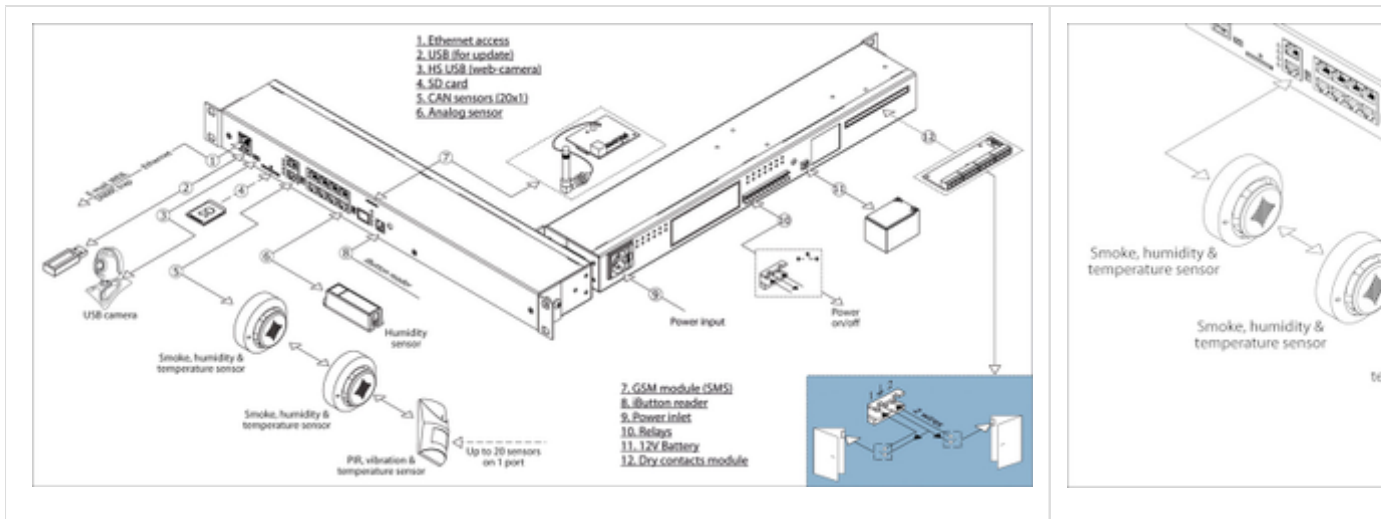

This procedure applies to the following sensors, which are supported by the appliance and are connected to the CAN ports:

CAN sensors, modules:

- [VT408 / Extension unit](#)
- [VT430 / Rack control unit](#)
- [VT440 / Dry contacts unit](#)
- [VT460 / Smoke, humidity, and temperature...](#)
- [VT470 / PIR, vibration and temperature sensor](#)
- [VT490 / Humidity and temperature sensor](#)
- and other...

CAN extension unit:

- [VT408 / Extension unit](#)

[Read more about Setting up CAN sensors.](#)

Used cable and limit line length

The maximum length of the CAN line in Vutlan monitoring systems is **225 m** due to limitations on the ohmic resistance of cables with RJ12 connectors.

It is advisable to use two or three pairs of cables such as UTP Cat3.5.6 with 24AWG with a copper core. It is possible to use a 4-wire or 6-wire TRONIC or UTP CCA cable, but the maximum CAN line length will be reduced.

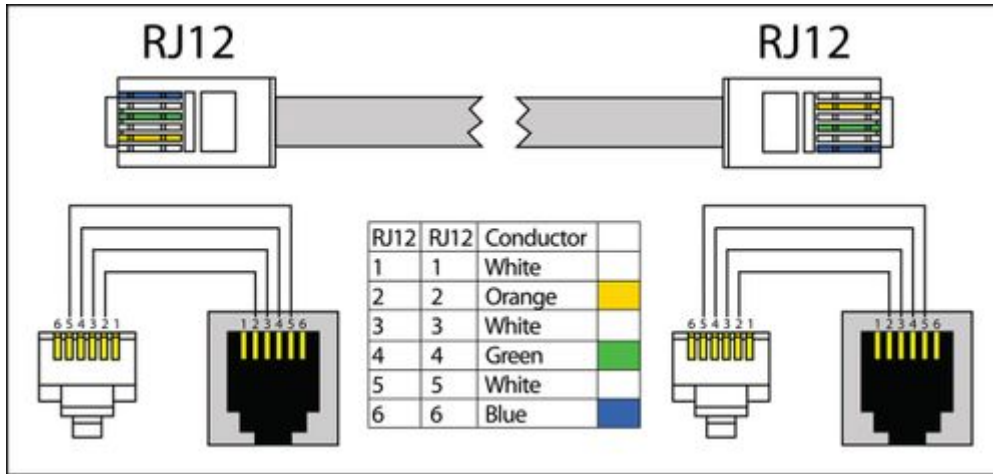

TR termination switch

⚠ The last sensor TR switch on a CAN chain must always be terminated, (switched ON). Sensors on a CAN bus that is in the middle should have TR switched OFF.

⚠ FR should always be OFF.

ℹ TR switch is always the DP switch nearest to the CAN bus.

⚠ Only older Vutlan models have FR switch.

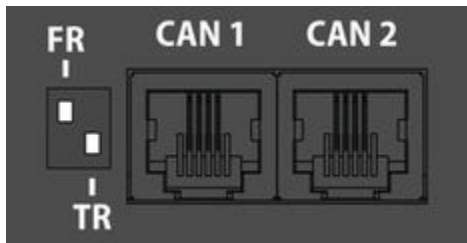

pic.1.1: FR is OFF, TR is ON.

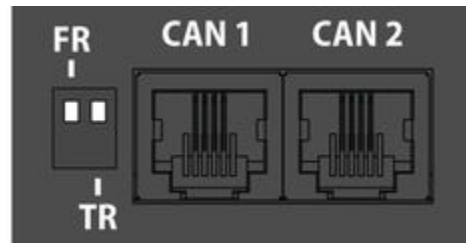

pic.1.2: FR is OFF, TR is OFF.

Adding CAN modules and sensors

To connect CAN module or CAN sensor to the CAN bus of the system, go to the interface >> CAN configuration panel >> Select the CAN1 or CAN2 tab (select the connected physical CAN1 or CAN2 port on the master module).

Click the "Configure" button and wait. The system will start CAN bus polling, soon it will display the data lines and write "Done!". The modules and sensors connected to the CAN input will appear in a tab in the list. Click the Apply button and then Restart.

The green LED "CAN status" of the device will light up.

VUTLAN
Monitoring & Control Systems

operator

- Overall stats
- System tree
- Outlets
- Dry outputs
- Dry inputs
- Event log
- Logic schemes
- Cameras
- Map
- Users
- Access control
- CAN configuration**
- Graphs
- Reset smoke detectors
- Preferences
- System menu

CAN configuration

CAN 1

Network name: can0
State: up
Mode: normal
Last update time: 2020-05-13 8-42-42 PM

Product code	Description
VT440 (6)	32/64 dry contacts
VT460 (7)	Smoke, temperature, humidity
VT430 (10)	PIR sensor, 2 dry, humidity, temperature
VT490 (8)	Temperature, humidity
VT490 (8)	Temperature, humidity
VT490 (8)	Temperature, humidity
VT430 (10)	PIR sensor, 2 dry, humidity, temperature
VT430 (10)	PIR sensor, 2 dry, humidity, temperature
VT430 (10)	PIR sensor, 2 dry, humidity, temperature
VT430 (10)	PIR sensor, 2 dry, humidity, temperature

Refresh Save Configure Restart

Go to panel "System Tree" to see the new devices or new sensors. The article numbers for CAN devices are VT4xx. If they do not appear, wait, or refresh.

i If after clicking the "Configure" button the poll is reset to the phrase "Update", then the line is not connected or the terminators on the bus are not agreed. It is necessary to check and change the condition of the **TR terminators** (See "TR termination switch" section above) on the modules or check and possibly change the **connection cables**.

x Warning: If the bus is not matched, that is, there are bad contacts or bad cables, or the TR terminator is in "ON" position on the intermediate devices (position 2 on the VT408), or the line is too short for matching on both CAN end devices, CAN on this line can work malfunctioning or the line as a whole may not function. (CAN line failure may occur if the parallel CR switch is in state 1, must be in OFF).

LEDs

CAN sensors have LEDs that indicate the following states:

- Red continuous light, green flickers - no communication with the master module
- Red continuous light, green is off - there is a connection with the master unit, but is not included in the monitoring system (not configured)
- Red is off, Green continuously light - work as part of a monitoring system
- All LEDs are off: no power or sensor is defective.

see also:

- [VT408 / Extension unit](#)
- [VT408DIN / Extension unit](#)

- VT430 / Rack control unit
- VT440 / Dry contacts unit
- VT460 / Smoke, humidity, temperature sensor
- VT490 / Humidity and temperature sensor
- CAN-12V-1A / CAN Power Supply

CAN configuration

Enable CAN

Inside the web interface of the system go to >> Preferences menu >> Network tab >> Enable CAN >> Save >> Save settings to flash (An icon in the top right corner of the web interface)

Configuration

CAN bus is used for connection of CAN sensors and CAN modules. The device has two independent CAN nodes: CAN1 and CAN2.

Before using CAN sensor module, CAN bus must be configured in order to operate with this CAN sensor module. To configure CAN bus go to "Main menu" >> "CAN" menu, which in turn has two identical tabs - one for each node.

Product code	Description
sc470 (1)	Motion, vibration, temperature
sc408 (4)	8 analog (with auto detecting) sensors

Each station tab contains current information on the status of the node and a list of CAN sensor modules connected to this node.

The following operations can be carried out on CAN bus node:

- Refresh - updates the current information on the status of the node;
- Configure - launches configuration process of the nodes for CAN sensor modules connected to it, the old configuration is lost
- Save - saves the list of CAN sensor modules in flash memory;
- Restart - restarts the CAN bus node.

To delete a CAN sensor module, click on a desired module. A modal window will pop up. Press "Delete" and confirm.

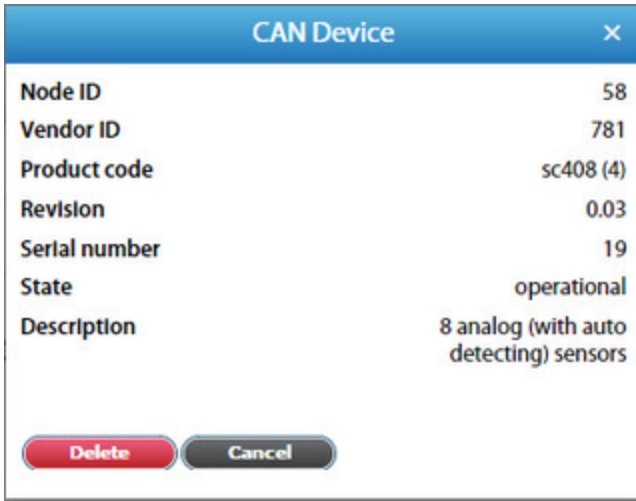

To set up a CAN bus node for operation with the CAN sensor module, connect CAN module to CAN network and run corresponding configuration procedure in the web-interface using command "Configure". The configuration process is displayed at the bottom of the tab and lasts approx. 2 minutes. Detected modules will be added to the list of modules during the configuration process. After completing configuration the node returns to its normal operation. Sensors of detected CAN modules are added to the tree of elements.

The names of the sensors are automatically set in the form {module name}-{serial number}-{type of sensor} and can be edited.





If you need to remove CAN sensor module from the configuration list use command Delete, then use command "Save" to apply the changes you made and restart the node using command Restart.

- [Configuring VT408](#)

Packaging includes

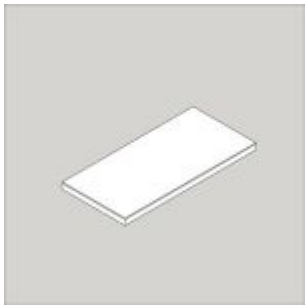
Make sure that the contents of the delivery meet the following configuration. Report a missing or damaged component to your supplier. If damage occurred during transportation, contact the appropriate delivery service.

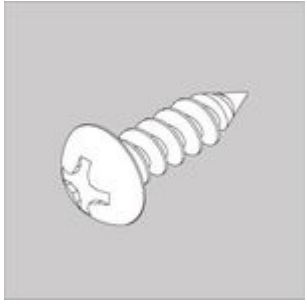
Package content	Description
	CAN Power supply module
	RJ11 6P4C 2m

 A white, rectangular self-adhesive sticker is shown against a dark gray background.	x2 pcs, Self-adhesive sticker
 A white screw with a hexagonal head and a threaded shaft, shown against a dark gray background.	x2 pcs, Screws M3.5 10mm
 A white screw with a hexagonal head and a threaded shaft, shown against a dark gray background.	x2 pcs, Screws M3,5 13,5mm
 A white hexagonal nut with a threaded hole, shown against a dark gray background.	x2 pcs, Nuts M3.5
 A white washer with a central hole, shown against a dark gray background.	x2 pcs, M3.5 washers

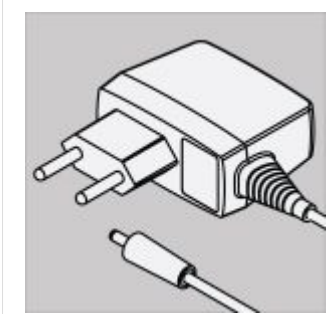

12V DC power supply

Copyright:

Vutlan s.r.o.

Remote Infrastructure Monitoring and Control

43 ul.Svornosti, 821 06 Bratislava,

Slovak Republic, E.U.

www.vutlan.com