



## User manual Nano Temperature Sensor POE



## Nano Temp Sensor



Soft >= 1.21

**INVEO s.c.**  
ul. Rzemieślnicza 21  
43-340 Kozy  
tel: +48 33 444 65 87  
[www.inveo.com.pl](http://www.inveo.com.pl)  
[info@inveo.com.pl](mailto:info@inveo.com.pl)

## **Dear Customer!**

Thank you very much for choosing our product. Before its use, please read these instructions carefully. Here you find the most appropriate ways of dealing with this device, the basic principles of safety and maintenance. Please, also keep the user manual so that you can read it during later use.

### **Attention!**

**The manufacturer is not liable for any damage caused by improper use of the device which differ from its intended purpose, or improper handling, as well as a fault of driver resulting from improper use.**

**Contents:**

- 1 PRELIMINARY INFORMATION.....4**
- 2 APPLICATION OF THE DEVICE.....5**
- 3 WARRANTY AND LIABILITY OF THE MANUFACTURER.....5**
- 4 SAFETY GUIDELINES.....6**
  - 4.1 STORAGE, WORK AND TRANSPORT CONDITIONS.....6
  - 4.2 INSTALLATION AND USE OF THE DEVICE.....6
  - 4.3 DECOMMISSIONING OF THE DEVICE.....6
- 5 CONSTRUCTION OF THE DEVICE.....7**
  - 5.1 NANO TEMPERATURE SENSOR PoE.....7
  - 5.2 NANO TEMP.....9
- 6 CONFIGURATION OF THE DEVICE.....11**
  - 6.1 CHANGING THE DEVICE'S IP ADDRESS BY DISCOVERER APPLICATION.....11
  - 6.2 CHANGING THE PC'S SUBNET ADDRESS, FOR THE DEVICE CONFIGURATION.....12
  - 6.3 SECURITY SETTINGS AND ADMINISTRATION.....14
- 7 THE DEVICE FUNCTIONS.....15**
  - 7.1 PREVIEW OF THE MEASURED TEMPERATURE.....15
  - 7.2 ALARMS.....15
  - 7.3 DESTINATION CLIENT.....17
  - 7.4 SNMP CONFIGURATION.....21
  - 7.5 WINDOWS COMMAND LINE SOFTWARE.....22
  - 7.6 LINUX CONTROL PROGRAM.....22
  - 7.7 MODBUS TCP.....23
  - 7.8 MQTT INVEO.....24
  - 7.9 COMMUNICATION WITH MODULE USING HTTP.....25
  - 7.10 DESCRIPTION OF THE COMMUNICATION PROTOCOL.....27
- 8 COMMUNICATION WITH THE MODULE FROM THE EXTERNAL NETWORK.....28**
- 9 CHECKING THE IP ADDRESS.....28**
- 10 DHCP.....28**
- 11 RESTORING FACTORY DEFAULTS.....29**
- 12 FIRMWARE UPDATE.....29**

## 1 Preliminary information

---

**Before starting work with the device, read The User manual and follow the instructions contained therein!**

Description of visual symbols used in this user manual:



This symbol is responsible for reviewing the appropriate place in the user instructions, warnings and important information. Failure to follow warnings could cause injury or damage to the device



Important information and guidelines



Following this guidelines makes the use of the device easier

**Attention:** The screenshots in this manual can be dissimilar from actual images at the time of the device purchase. Due to continuous development of the devices software, some of the functions may differ from these in the manual. The manufacturer claims no responsibility for any undesirable effects (misunderstanding) caused by changes of the software.

## 2 Application of the device

---

NANO Temperature Sensor module is used to read temperature over different LAN protocols. The temperature readout is possible using built in www website, HTTP GET, Modbus TCP, SNMP and MQTT protocols. This module can communicate with other Inveo modules and e.g. trigger relay actions.

## 3 Warranty and liability of the manufacturer

---



The manufacturer provides a 2-year warranty on the device. The manufacturer also provides post-warranty service for 10 years from the date of the introducing the device on the market. The warranty covers all defects in material and workmanship.

The manufacturer undertakes to comply with the contract of guarantee, if the following conditions are met:

- all repairs, alterations, extensions and device calibrations are performed by the manufacturer or authorized service,
- supply network installation meets applicable standards in this regard,
- the device is operated in accordance with the recommendations outlined in this manual,
- the device is used as intended.

The manufacturer assumes no responsibility for consequences resulting from improper installation, improper use of the device, not following this manual and the repairs of the device by individuals without permission.



**This device doesn't contain serviceable parts.**

## 4 Safety guidelines

---

The device has been designed and built using modern electronic components, according to the latest trends in the global electronics. In particular, much emphasis was placed on ensuring optimum safety and reliability of control. The device has a housing with a high-quality plastic.

### 4.1 Storage, work and transport conditions

The device has to be stored in enclosed rooms which are free of caustic vapors and substances and also meet the requirements:

- surrounding temperature from  $-30^{\circ}\text{C}$  to  $+60^{\circ}\text{C}$ ,
- humidity from 25 to 90%,
- atmospheric pressure from 700 to 1060hPa.

The device working conditions:

- surrounding temperature from  $-10^{\circ}\text{C}$  to  $+55^{\circ}\text{C}$ ,
- relative humidity from 30% to 75%,
- atmospheric pressure from 700 to 1060hPa.

Recommended transport conditions:

- surrounding temperature from  $-40^{\circ}\text{C}$  to  $+85^{\circ}\text{C}$ ,
- relative humidity from 5% to 95%,
- atmospheric pressure from 700 to 1060hPa.

### 4.2 Installation and use of the device

 **The device should be used following the guidelines shown in next part of the user manual.**

### 4.3 Decommissioning of the device

When it becomes necessary to recycle the device (for instance, to decommission the device from service), please contact the manufacturer or its representative, who are obliged to respond, appropriately, i.e. collecting the device from the user. You can also ask the companies involved in recycling of electrical or computer equipment. Under no circumstances should you place the device along with other waste material.

## 5 Construction of the device

---

### 5.1 Nano Temperature Sensor PoE

#### Technical data:

##### Power supply::

PoE: 33-57V POE IEEE 802.3af

DC: 10-24VDC (screw terminals 3,5mm)

Power consumption: max 1,5W

##### Inputs:

1 input:                   input type: 1-wire bus  
                                  type of sensor: DS18B20  
                                  temperature measured: -55°C do +125°C  
                                  screw connection

##### Communication:

1 port Ethernet:       10Mbps  
                                  PoE IEEE 802.3af

##### Housing:

IP Code: 30

Dimensions:

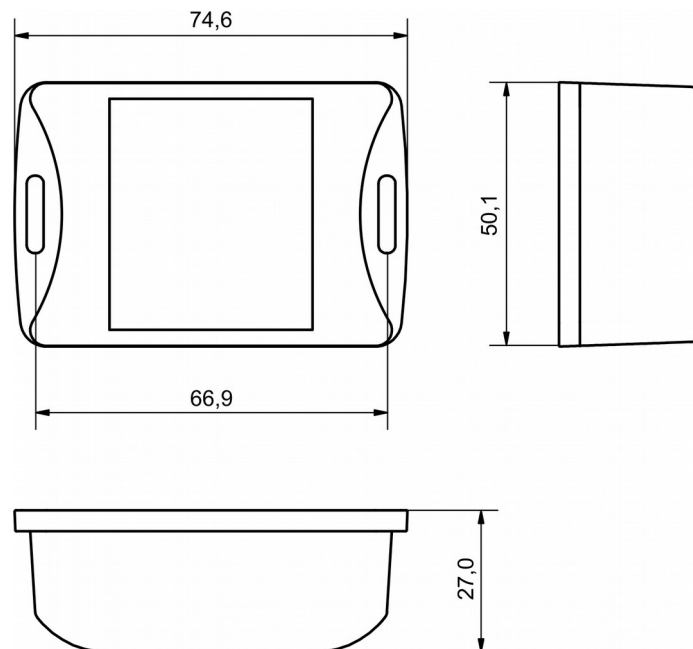

## General features:



The device has a 7-segment display.

There are several ways to communicate with the module:

- using built in WWW server via any web browser,
- Windows / Linux command line programs,
- MODBUS TCP protocol,
- SNMP protocol,
- MQTT Inveo protocol,
- User application – TCP protocol available for user.

## Description of the module connectors:

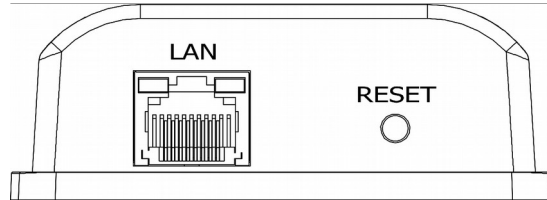

- **LAN** – LAN connection and PoE IEEE 802.3af power supply,
- **RESET** – switch used to enabling DHCP service, checking the current IP address and restoring the module to the factory settings.



- **1-WIRE** – screw connection for connection of the temperature sensor,
- **POWER** – power connector. An additional power connector used in the event of a PoE power failure. Supply voltage 10-24VDC.



## 5.2 Nano Temp

### Technical data:

#### Power supply:

The module is adapted to 12-24VDC power supply.  
Power is supplied through the passive PoE adapter.

#### Inputs:

1 input:                   input type: 1-wire bus  
                              type of sensor: DS18B20  
                              temperature measured: -55°C do +125°C  
                              screw connection

#### Communication:

1 port Ethernet:       10Mbps  
                              passive PoE 12-24VDC power supply

#### Housing:

IP Code: 30  
Dimensions:

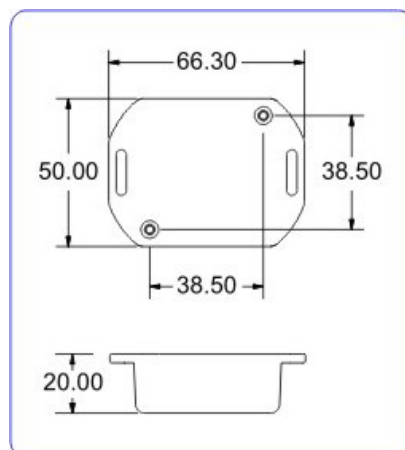

## General features:



The device has two LEDs. LEDs indicate power supply and temperature reading.

There are several ways to communicate with the module:

- using built in WWW server via any web browser,
- Windows / Linux command line programs,
- MODBUS TCP protocol,
- SNMP protocol,
- MQTT Inveo protocol,
- User application – TCP protocol available for user.

## Description of the module connectors:

- **LAN** – LAN network and Passive PoE power supply,
- **RESET** – switch used to enabling DHCP service and restoring the module to the factory settings.
- **1-WIRE** – screw connection for connection of the temperature sensor.

## 6 Configuration of the device

The device when used for first time needs to be configured.

There are two methods to do so. The network configuration can be easily changed by Inveo "Discoverer" (<https://inveo.com.pl/software/>) software:

### 6.1 Changing the device's IP address by Discoverer application

When the "Discoverer" is opened and the relevant device is found, choose Interface list box and click on Change IP button.

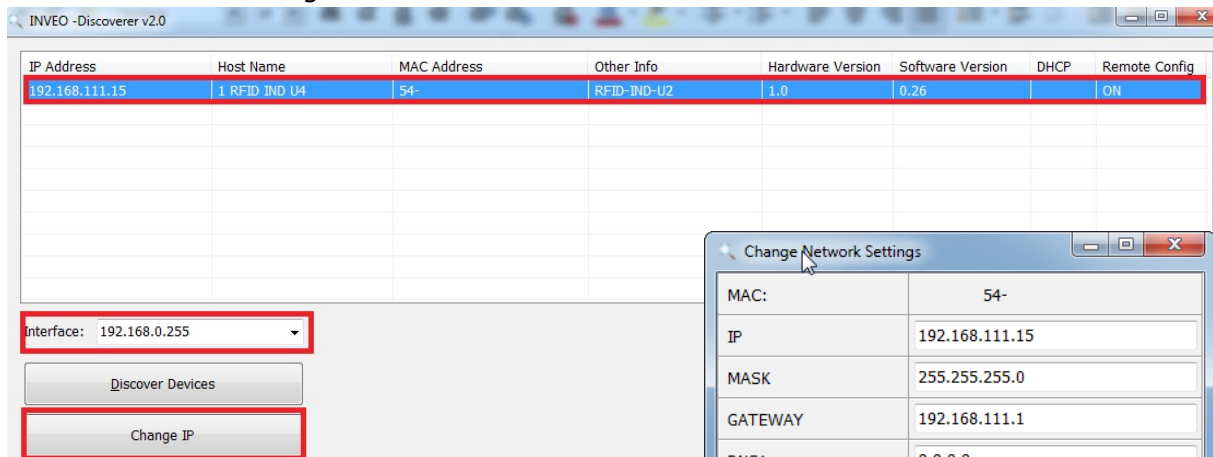

In a new opened dialog box, settings such as IP address, MASK, GATEWAY, DNS1/DNS2 and the Host name can be changed.

Please save correct settings by choosing **Change** button.

If **Remote Config** is disabled (enabled by default), it is necessary to configure the device by changing the computer's subnet (chapter 6.2).

To enable the remote configuration it is necessary to enter **Administration** tab and mark **Enable Remote Network Config**.

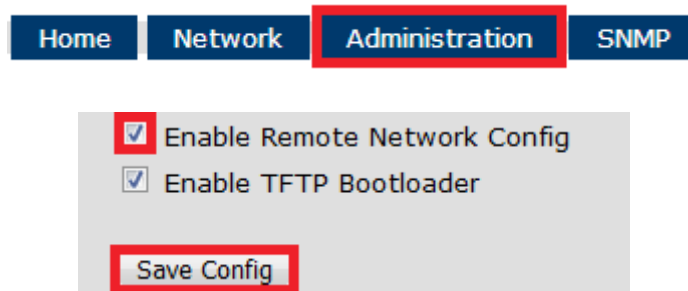

Save the setup by selecting **Save Config** button.

## 6.2 Changing the PC's subnet address, for the device configuration

After the device is connected to a network, a subnet address of a PC which is connected to the same network has to be changed.

To do so, go to the PC's MS Windows network configuration: Start->Control panel ->Network and Sharing Center->Network and Internet->Network Connections, choose the related controller and right click on „Properties“.

After selecting this option configuration window will show up:

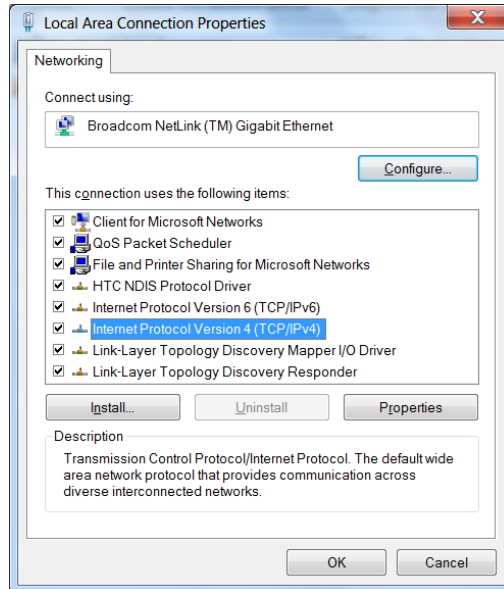

Changing network settings in MS WINDOWS

Next choose "Internet Protocol (TCP/IP)", double click on it and enter following settings:

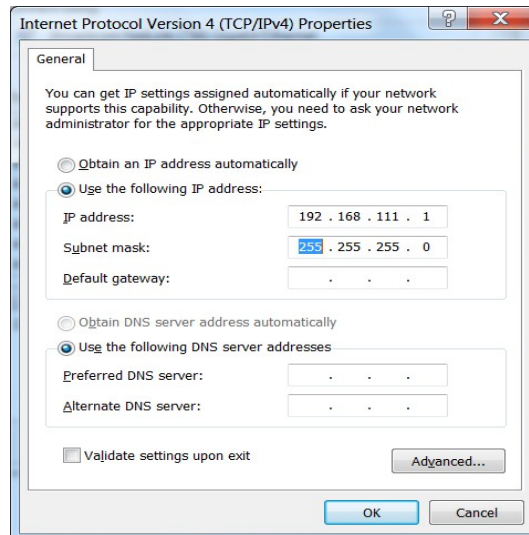

Illustrative TCP/IP protocol settings

After saving changes by clicking OK, open an Internet browser and enter in the browser's address line: **192.168.111.15**.

**Default user name/password:** admin/admin00

In the **Network** tab it is possible to change LAN parameters.

**inveo** Inveo Nano Temperature SV:1.17

Home Channel **Network** SNMP Administration

## Network Configuration

This page allows the configuration of the device's network settings.

MAC Address:	<input type="text"/>
Host Name:	NANO
	<input type="checkbox"/> Enable DHCP
IP Address:	192.168.111.17
Gateway:	192.168.111.1
Subnet Mask:	255.255.255.0
Primary DNS:	8.8.8.8
Secondary DNS:	8.8.4.4
Destination IP:	0.0.0.0
Destination Port:	0
	<input type="button" value="Save Config"/>

To change the network settings, use the following fields:

- **Host Name** – NETBIOS name,
- **DHCP** – checking this box forces use of the address assigned by the DHCP server,
- **IP Address** – the IP address of the reader,
- **Gateway** – network gateway,
- **Subnet Mask** – IP subnet mask,
- **Gateway** – network gateway,
- **DNS1, DNS2** – DNS servers addresses.
  
- **Destination IP** – the IP address of the device in the M2M connection (chapter 7.3),
- **Destination Port** – the listening port of the external device in the M2M connection.

After all changes, select **Save Config**.

### 6.3 Security settings and administration

The **Administration** settings allow for changing access password and to enable/disable particular services in the device.

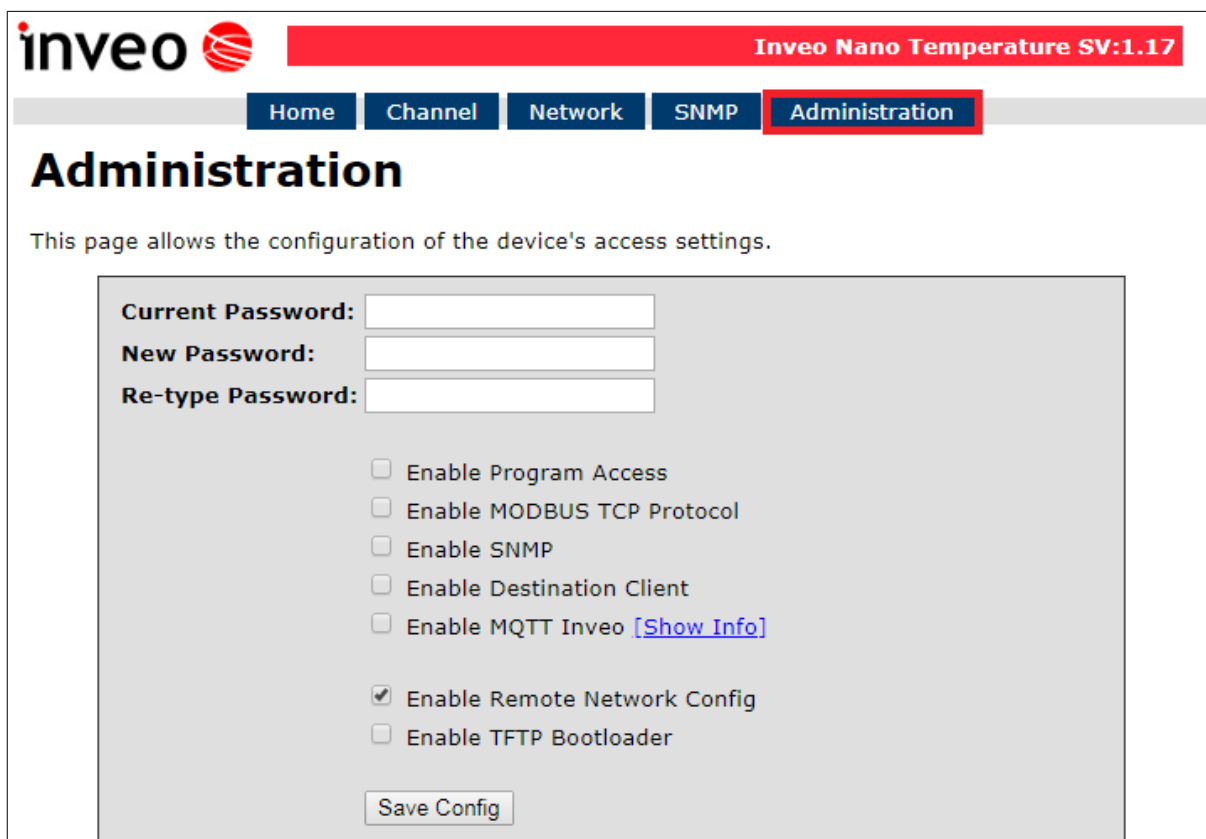

#### Password change

To change password, in the **Current Password** field write a current password. Next, in the **New Password** field write your new password and confirm it at **Re-type Password** field.

#### Service settings

The device allows to choose which services are to be available. Selecting the check box next to the service name activates the selected service.

**Enable Program Access** – a service of access by a computer program (Windows, Linux) and TCP / IP protocol operating on port 9761,

**Enable MODBUS TCP Protocol** – enables Modbus TCP server,

**Enable SNMP** – enables SNMP protocol supporting,

**Enable Destination Client** – connecting to a remote host service (chapter 7.3),

**Enable MQTT Inveo** – a service that sends data to the INVEO MQTT cloud,

**Enable Remote Network Config** – remote configuration (via the Discoverer application),

**Enable TFTP Bootloader** – enables a bootloader.

#### Attention:

**TFTP Bootloader** and **Remote Network Config** ought to be disabled during normal work operation. It should be enabled for a firmware update only.



## 7 The device functions

### 7.1 Preview of the measured temperature

In the **Home** tab, the current temperature read from the sensor connected to the bus is displayed and the over temperature condition is signaled.

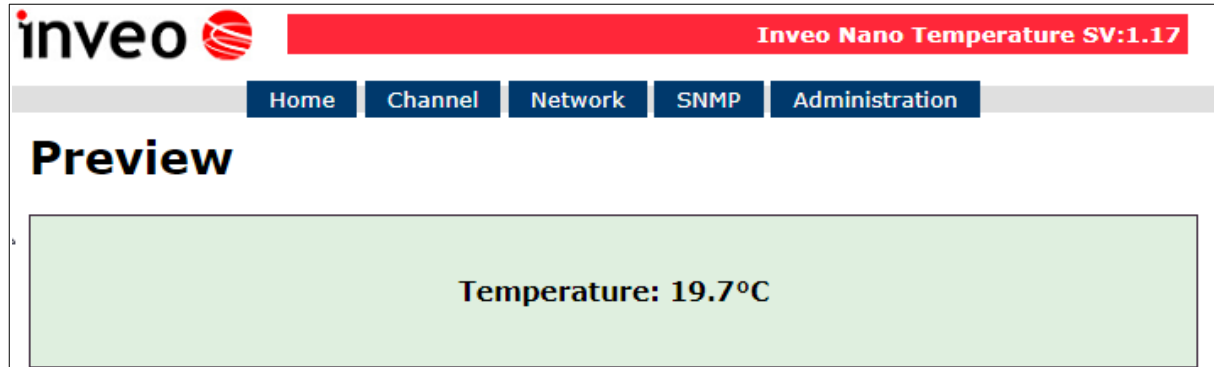

### 7.2 Alarms

In the **Channel** tab, it is possible to set alarm thresholds. If the temperature is out of range, the alarm will be active.

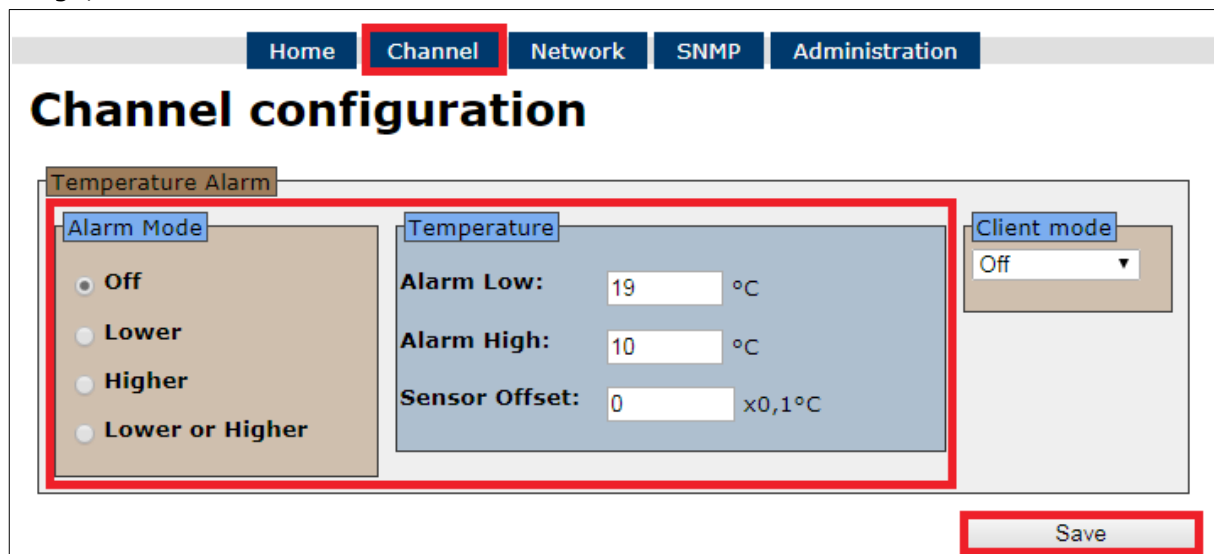

#### Alarm Mode

- **Off** – alarm disabled,
- **Lower** – if the temperature is lower than value set in the **Alarm Low** field, the alarm will be active.
- **Higher** – if the temperature is higher than value set in the **Alarm High** field, the alarm will be active.
- **Lower or Higher** – if the temperature is lower than value set in the **Alarm Low** field or if the temperature is higher than value set in the **Alarm High** field, the alarm will be active.

**Sensor Offset** – the value that will be added to the measured value.

All changes must be confirmed with the **Save** button.

The occurrence of an **alarm** condition is signaled on the **homepage** of the module, and the display or LED is flashes.

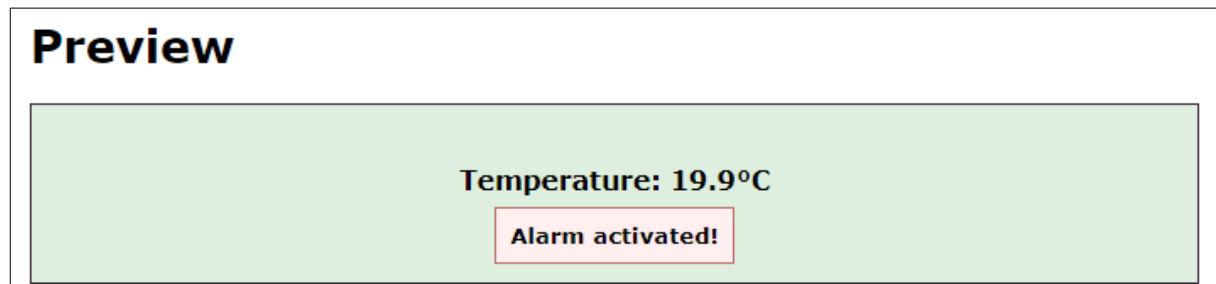

If the alarm is active, the virtual output No. 1 is enable (`<on>00000001</on>`).  
The virtual output state is in the **status.xml** resource.

**<http://192.168.111.15/status.xml>**

```
<response>
<prod_name>Nano-DS</prod_name>
<sv>1.17</sv>
<mac>54:10:EC:BB:61:17</mac>
<out>00000000</out>
<on>00000001</on>
<in>00000000</in>
<counter1>0</counter1>
<temp1>18.8</temp1>
</response>
```

### Attention!

If an alarm has occurred, return to normal device operation (without alarm signaling) will take place only after crossing the hysteresis zone equal to 1 degree Celsius.

For example, if the **Alarm Low** is set to 20 degrees Celsius, the alarm will be activated when the temperature reaches 20 degrees and turns off when the temperature reaches 21 degrees Celsius.



### 7.3 Destination Client

**Inveo devices as** LanTick, Nano Temperature Sensor, Nano Digital Input, Nano Relay Output or others **are able to send information data to the server or to another module with outputs** using the TCP or UDP protocol. It means that this another module can react to activation of channel or when alarm occurs (Nano Sensors). The message is sent each time state is changed and additionally every 5 seconds.

#### Configuration of devices receiving messages (external devices)

To enable the service, enter the **Administration** tab and select **Enable Program Access** and confirm with the **Save Config** button.

#### Configuration of devices sending alarm status messages

To enable the service, enter the **Administration** tab and select **Enable Destination Client** and confirm with the **Save Config** button.

The screenshot shows the Inveo Nano Temperature SV:1.17 web interface. The top navigation bar includes 'Home', 'Channel', 'Network', 'SNMP', and 'Administration' (highlighted). The main heading is 'Administration'. Below it, a message states: 'This page allows the configuration of the device's access settings.' The configuration area contains three password input fields: 'Current Password:', 'New Password:', and 'Re-type Password:'. Below these are several checkboxes: 'Enable Program Access', 'Enable MODBUS TCP Protocol', 'Enable SNMP', 'Enable Destination Client' (checked and highlighted with a red box), 'Enable MQTT Inveo [Show Info]', 'Enable Remote Network Config', and 'Enable TFTP Bootloader'. At the bottom of the configuration area is a 'Save Config' button, also highlighted with a red box.

In the **Network** tab, fill in the **Destination IP** and **Destination Port** fields. The **Destination IP** field is an IP address of the external device or a server. The **Destination Port** field is a port number of the external device (9731 by default).

The screenshot shows two input fields: 'Destination IP:' with the value '0.0.0.0' and 'Destination Port:' with the value '0'. Below these fields is a 'Save Config' button.

Then, in the **Channel** tab select the appropriate output which will be enabled in the external device or – select type of the message.

**Channel configuration**

Temperature Alarm

**Alarm Mode**

Off

Lower

Higher

Lower or Higher

**Temperature**

Alarm Low: 10 °C

Alarm High: 15 °C

Sensor Offset: 0 x0,1°C

**Client mode**

TCP Ch:1

Off

TCP Ch:1

TCP Ch:2

TCP Ch:3

TCP Ch:4

TCP Ch:5

TCP Ch:6

TCP Ch:7

TCP Ch:8

Status

MAC+Status

HTTP GET

UDP Ch:1

Copyright © 2018 [Inveo s.c.](#)

The user can choose the following fields:

- **TCP Ch:x** – the function uses **the connection protocol** i.e. the TCP protocol. Number **Ch:x** is selected output channel in an external device, e.g. LanTick, which will be enabled when the channel state of the local device changes. The TCP frame sends in the **format #1**,
- **UDP Ch:x** – the function uses **the connectionless protocol** i.e. the UDP protocol. Number **Ch:x** is selected output channel in an external device, e.g. LanTick, which will be enabled when the channel state of the local device changes. The UDP frame sends in the **format #1**,
- **Status** – sends the device channel status, TCP frame sent in the **format #2**,
- **MAC+Status** – sends the MAC address of the device and current channel status, TCP frame sent in the **format #3**,
- **HTTP GET** – sends the MAC address of the device current alarm status and temperature value, frame sent in the **format #4**.

## TCP frames formats

### Format #1

The frame in the format #1 is sent in binary form.

An example TCP frame sent with active alarm and **Dest:5** set

SOF	CMD	CH	F_ID	ALARM	!ALARM	TEMP	RES	RAW LSB	RAW MSB	CRC
0x0F	0x01	<b>0x04</b>	0xFF	<b>0x01</b>	0xFE	<b>0x0F</b>	0x00	<b>0x01</b>	<b>0x57</b>	0x7F

An example TCP frame sent with inactive alarm and **Dest:5** set

SOF	CMD	CH	F_ID	ALARM	!ALARM	TEMP	RES	RAW LSB	RAW MSB	CRC
0x0F	0x01	<b>0x04</b>	0xFF	<b>0x00</b>	0xFF	<b>0x0F</b>	0x00	<b>0x01</b>	<b>0x57</b>	0x7F

Values **RAW\_LSB** and **RAW\_MSB** is the temperature read directly from the sensor.

The temperature read off should be divided by 16

Value **TEMP** it's the temperature without the decimal part.

Calculation of CRC:

$$\text{CRC} = (\text{SOF} + \text{CMD} + \text{CH} + \text{F\_ID} + \text{ALARM} + \text{!ALARM} + \text{TEMP} + \text{RES} + \text{RAW\_LSB} + \text{RAW\_MSB}) \text{ MOD } 256$$

### Format #2

The frame #2 is sent as a string (STRING).

<ALARM>[SPACE]<TEMPERATURE>

- **ALARM** – value 1 means an alarm is active, 0 means an alarm is inactive
- **TEMPERATURE** – read temperature

Value in HEX	STRING
30 20 33 39 2E 35	0 39.5

### Format #3

The frame #3 is sent as a string (STRING).

<MAC>[SPACE]<ALARM>[SPACE]<TEMPERATURE>

- **MAC** – network address of the module,
- **ALARM** – value 1 means an alarm is active, 0 means an alarm is inactive,
- **TEMPERATURA** – read temperature.

Value in HEX	STRING
35 34 31 30 45 43 36 35 35 30 32 31 20 30 20 34 36 2E 39	5410EC655021 0 46.9

#### Format #4

Setting Client Mode to **HTTP GET** causes that the device sends data to the server in the form:

nano.php?mac=<MAC>&io=<Alarm>&cnt=<Temperature>

- **MAC** – MAC address,
- **Alarm** – value 1 means active alarm, 0 means inactive alarm,
- **Temperature** – counter temperature value.

An example of a frame received by the server:

GET /nano.php?mac=**123456789012**&io=**0**&value=**7**

MAC address = 123456789012,

io=0,                   the input is inactive

value=7,                the current temperature value 7

#### The TCP frame can be handled with your own software.

An example of using the netcat command for Linux:

Format #1

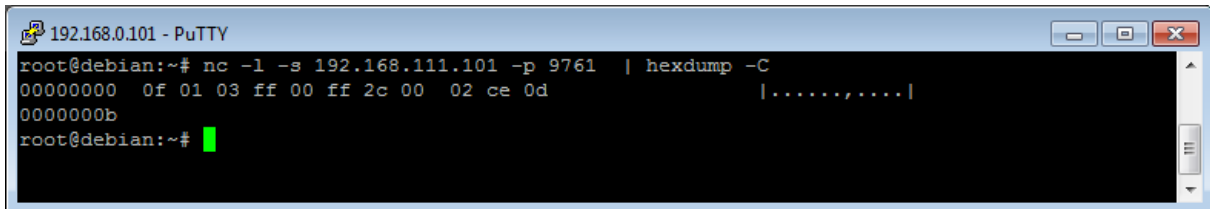

```
192.168.0.101 - PuTTY
root@debian:~# nc -l -s 192.168.111.101 -p 9761 | hexdump -C
00000000  0f 01 03 ff 00 ff 2c 00 02 ce 0d  |.....|
0000000b
root@debian:~#
```

Format #2

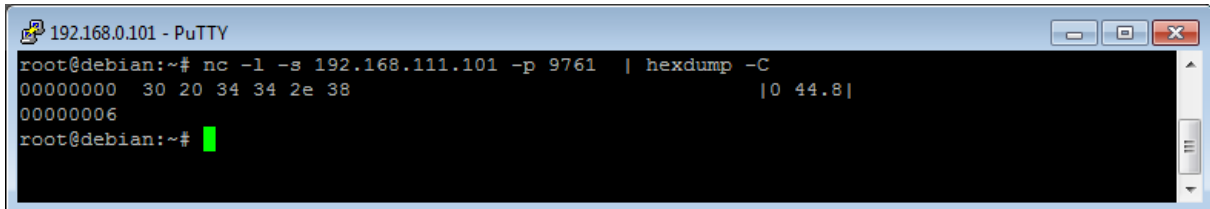

```
192.168.0.101 - PuTTY
root@debian:~# nc -l -s 192.168.111.101 -p 9761 | hexdump -C
00000000  30 20 34 34 2e 38  |0 44.8|
00000006
root@debian:~#
```

Format #3

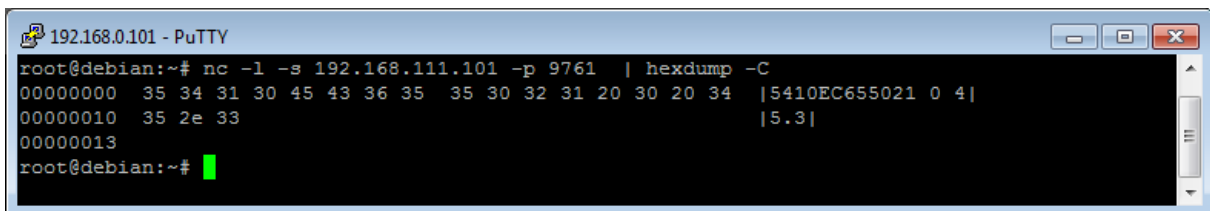

```
192.168.0.101 - PuTTY
root@debian:~# nc -l -s 192.168.111.101 -p 9761 | hexdump -C
00000000  35 34 31 30 45 43 36 35 35 30 32 31 20 30 20 34  |5410EC655021 0 4|
00000010  35 2e 33  |5.3|
00000013
root@debian:~#
```

## 7.4 SNMP configuration

The module is equipped with an SNMP v2c server.

To enable this feature go to **Administration** tab and check **Enable SNMP** option.

The SNMP protocol allows to read the current value.

The MIB file describing the structure can be downloaded the **SNMP** tab.

**inveo** Inveo Nano Temperature SV:1.17

Home Channel Network **SNMP** Administration

### SNMP Configuration

Configuration for SNMP v2c Agent.

Read Community : public

Write Community: private

Trap IP Address 1: 0.0.0.0  
 Enable Trap 1

Trap IP Address 2: 0.0.0.0  
 Enable Trap 2

Save Config

[Download MIB file](#)

The basic parameters that can be read from the Nano Temperature Sensor module can be found in the table:

Name	Format	OID
CH1_TEMP	STRING	.1.3.6.1.4.1.42814.14.3.5.1.0
CH1_TEMPINT (integer)	INTEGER	.1.3.6.1.4.1.42814.14.3.5.2.0
CH1_TEMPINT10 (temperature *10)	INTEGER	.1.3.6.1.4.1.42814.14.3.5.3.0
CH1_ON (Alarm active)	INTEGER	.1.3.6.1.4.1.42814.14.3.1.1.0

Module can send TRAP messages after alarm activation. Destination address should be entered in **Trap IP Address 1** and **Trap IP Address 2** fields.

### 7.5 Windows command line software

The module can be operated using windows command line software.

To use the command line program, it is necessary to enable the **Access program** setting in the **Administration** tab.

Windows syntax:

TCPRel.exe [Parameters]

Parameter	Description
<b>-in=1</b>	The number of the input being read
<b>-host=[HOST]</b>	The IP address of the module
<b>-port=[PORT]</b>	Module port
<b>-readtemp</b>	Reading values from the sensor

#### Example:

Reading the current value, the module has an address: 192.168.111.15 and listens on port 9761:

```
TCPRel -in=1 -host=192.168.111.15 -port=9761 -readtemp
```

### 7.6 Linux control program

To use the linux command line software, it is necessary to enable the **Access program** setting in the **Administration** tab.

Syntax is as follows:

./TcpRel.exe [Parameters]

Parameter	Description
<b>-i 1</b>	The number of the input being read
<b>-h [HOST]</b>	The IP address of the module
<b>-p [PORT]</b>	Module port
<b>-t</b>	Reading values from the sensor

#### Example:

Read temperature from module at IP address 192.168.111.15 and port 9761:

```
./tcprel -i 1 -h 192.168.111.15 -p 9761 -t
```

## 7.7 Modbus TCP

The device supports Modbus TCP protocol.

The Modbus TCP server is available over LAN and listens on port 502.

### Supported Modbus functions

The device supports the following MODBUS functions:

- 0x01 Read Coils,
- 0x03 Read Holding Register,
- 0x06 Write Single Register,
- 0x0F Write Multiple Coils,
- 0x10 Write Multiple Registers.

### Modbus TCP – Coils

Address	Name	R/W	Description
1000	On1	R	Alarm state
1002	SensError	R	Sensor error (0-ok, 1-error)

### Modbus TCP – Holding Registers

Address	Name	R/W	Opis
4000	ThermostatL	R/W	Lower alarm threshold
4001	ThermostatH	R/W	Upper alarm threshold
4002	Alarm mode	R/W	1 – <b>OFF</b> (disabled) 2 – <b>Lower</b> 3 – <b>Higher</b> 4 – <b>Lower or Higher</b>
4004	Temperature x10	R	Temperature x 10 (np. 10,5 st.C to 105)
4005	Temperature Int	R	Integral part of temperature
4006	Temperature Frac	R	Decimal part of temperature
4007	MAC 0	R	MAC address
4008	MAC 1	R	MAC address
4009	MAC 2	R	MAC address
4010	MAC 3	R	MAC address
4011	MAC 4	R	MAC address
4012	MAC 5	R	MAC address
4013	StoreConfig	W	Entering 144 will save to configuration to EEPROM

## 7.8 MQTT Inveo

If the MQTT Inveo service has been enabled in the **Administration** tab, the module sends to mqtt.inveo.com.pl server the value of measured temperature every 1 minute and additionally at each change.

Application configuration – MQTT Client:

Address: mqtt.inveo.com.pl

Port: 1883

User name: nanouser

User password: nanouser

Topic: /nanoT/<MAC>

After click [\[Show Info\]](#) the settings for the MQTT client will be displayed:



There are many applications on Android, IOS or PC that can display data sent by the module.



### 7.9 Communication with module using HTTP

Modules can be controlled using HTTP GET.

To read current state of the module refer to a resource such as <http://192.168.111.15/status.xml>

XML file consist all of the information:

```
<response>
<prod_name>Nano-DS</prod_name>
<sv>1.20</sv>
<mac>00:00:00:00:00:00</mac>
<out>00000000</out>
<on>00000000</on>
<in>00000000</in>
<counter1>0</counter1>
<temp1>19.4</temp1>
</response>
```

Section	Description
<prod_name>PE-DS</prod_name>	Type of the module
<sv>1.20</sv>	The firmware version
<mac>00:00:00:00:00:00</mac>	MAC address
<out>00000000</out>	Output state (enabled/disabled), N/A in Nano Temperature Sensor
<on>00000000</on>	Status of virtual outputs: <b>00000001 means alarm state</b>
<in>00000000</in>	Input state (Active/Inactive), N/A in Nano Temperature Sensor
<counter1>0</counter1>	Counter inputs, N/A in Nano Temperature Sensor
<temp1>21.3</temp1>	Temperature sensor reading Temperature is 21.3 degree

To read measured temperature only, refer to the resource temp1.txt. The temperature will be displayed in text form.

For example:

<http://192.168.111.17/temp1.txt>

19.4

## Example of reading the measured value with the CURL command.

### Attention!

Access to resource **stat.php** require authorization.

Access to resources **status.xml** and **temp1.txt** do not require authorization.

```
curl "http://192.168.111.15/temp1.txt" -w "\n"
```

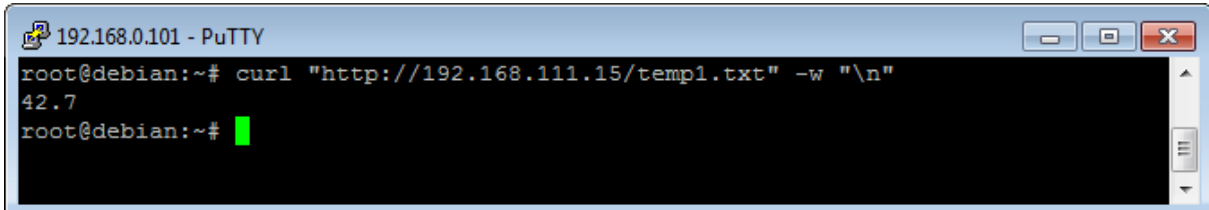

```
192.168.0.101 - PuTTY
root@debian:~# curl "http://192.168.111.15/temp1.txt" -w "\n"
42.7
root@debian:~# █
```

```
curl "http://192.168.111.15/status.xml" -w "\n" 2>/dev/null | grep 'temp1' |
awk -F "[><]" '/temp1/{print $3}'
```

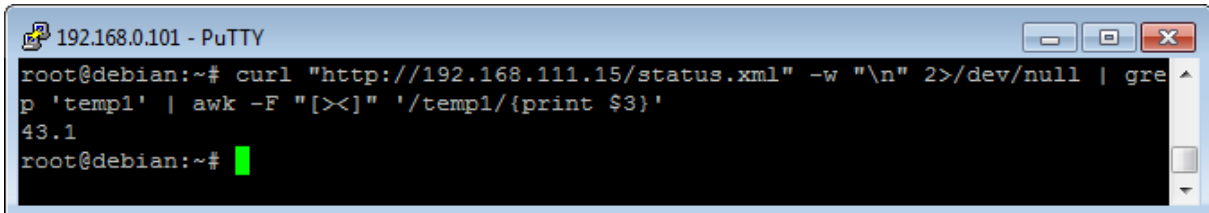

```
192.168.0.101 - PuTTY
root@debian:~# curl "http://192.168.111.15/status.xml" -w "\n" 2>/dev/null | gre
p 'temp1' | awk -F "[><]" '/temp1/{print $3}'
43.1
root@debian:~# █
```

```
curl -u admin:admin00 "http://192.168.111.15/stat.php" -w "\n" 2>/dev/null |
grep 'prod_name' | awk -F "[><]" '/prod_name/{print $3}'
```

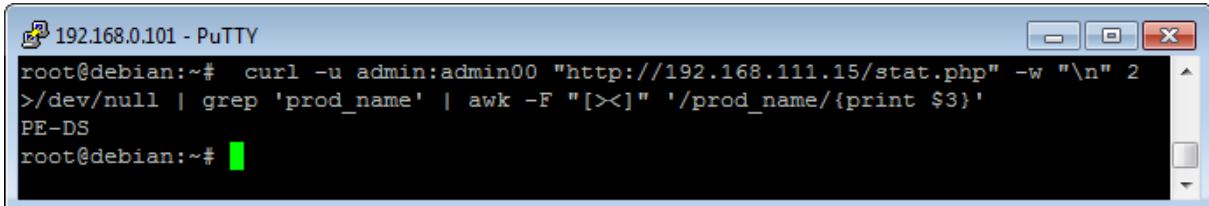

```
192.168.0.101 - PuTTY
root@debian:~# curl -u admin:admin00 "http://192.168.111.15/stat.php" -w "\n" 2
>/dev/null | grep 'prod_name' | awk -F "[><]" '/prod_name/{print $3}'
PE-DS
root@debian:~# █
```

### 7.10 Description of the communication protocol

Nano Temperature Sensor communication data frame.

Command	Byte number	1	2	3	4	5	6	7	8	9	10	11	
	Byte name	SOF	CMD	Channel	Data1	Data2	Data3	Data4	Data5	Data6	Data7	CRC	Returns
Temperature reading	dec	15	12	0	X	X	X	X	X	X	X	CRC	2 bytes + CRC
	hex	0x0F	0x0C	0x00	X	X	X	X	X	X	X	CRC	2 bytes + CRC

As default modules are listening on TCP port 9761.

Reading the current value from the temperature sensor.

SOF	CMD	CH	D1	D2	D3	D4	D5	D6	D7	CRC
0x0F	0x0C	0x00	0x00	0x00	0x00	0x00	0x00	0x00	0x00	0x1B

$$\text{CRC} = (\text{BYTE}) \text{ SUM (SOF+CMD+CH+D1..D7)}$$

The device returns 2 bytes (current temperature) + CRC (sum of 2 bytes)

#### Examples:

Temperature value	The value returned by the module to port 9761		Convert to dec format		Converted temperature value (dec/16)
dec	2 bytes	CRC	hex	dec	dec
-18,0	E0 FE	DE	FFFF-FEE0	287	-17,9375
-5,1	AE FF	AD	FFFF-FFAE	81	-5,0625
26,5	A8 01	A9	1A8	424	26,5
33,8	1E 02	20	21E	542	33,875

The converted decimal value have to be divided by 16.

## **8 Communication with the module from the external network**

---

If the module is in a different LAN network than the computer connecting to it, port forwarding is required.

Depending on the communication method used with the module, it is necessary to contact the Network Administrator and port forwarding:

### **Support via website and HTTP protocol:**

- port TCP 80

### **Service by a computer program or by your own application:**

- port TCP 9761

### **Support via MODBUS TCP:**

- port TCP 502

### **Support via SNMP protocol:**

- port UDP 161

## **9 Checking the IP address**

---

Concerns only Nano Temperature Sensor PoE.

To check the current IP address of the device:

1. Press and hold the reset button until the display shows the four parts of the IP number, e.g. **192 168 111 15**.
2. Release the reset button.

## **10 DHCP**

---

To enable/disable DHCP service:

1. Press and hold RESET button 5 to 10 second.
2. Green LED will start flashing 2 times a second (Nano Temperature Sensor), the display will show: **dhcP** (Nano Temperature Sensor PoE).
3. Release the reset button.

It is also possible to enable DHCP in the network configuration in the **Network** tab or through Discoverer application.

## 11 Restoring factory defaults

---

To reset the device to factory settings:

1. Press and hold RESET button for 10 to 15 seconds
2. Green LED will start flashing 2 times a second (Nano Temperature Sensor), the display will show: **rSt** (Nano Temperature Sensor PoE).
3. Release the reset button.

With factory defaults restored the module settings are as follows:

- DHCP: enabled
- IP address: 192.168.111.15
- IP mask: 255.255.255.0
- User name: admin
- Password: admin00

## 12 Firmware update

---

The device has the ability to update the firmware. The software update program is provided as a \*.bin file.

**Warning!** Incorrect use of the update feature may damage the reader. Make sure that undisturbed power is provided to the device for duration of programming.

To update the software:

- check the **Enable TFTP Bootloader** option, which is located in the Administration tab,
- run the Windows command line (Start-> Run enter 'cmd' and confirm with the Enter key),
- go to the directory where the .bin file is located
- enter the command:

```
tftp -i <address_ip_of the reader> PUT file.bin
```

where: <address\_ip\_of the reader> is the IP Address of the reader  
file.bin – the file with the update program

Programming takes 1-2 minutes. End of programming confirms the message 'File Transferred'.

For correct functioning of the reader, after the update operation the „**Enable TFTP Bootloader**” option has to be switched off.

Step-by-step instruction for firmware updates is available at <https://inveo.com.pl>.

**The latest instructions and software are available on the site <https://inveo.com.pl>.**