



## User manual The Relay Output Module

### Nano Relay Output PoE



### Nano Relay Output



Soft >= 1.21

**INVEO s.c.**  
ul. Rzemieślnicza 21  
43-340 Kozy  
tel: +48 33 444 65 87  
[www.inveo.com.pl](http://www.inveo.com.pl)  
[info@inveo.com.pl](mailto:info@inveo.com.pl)

## **Dear Customer!**

Thank you very much for choosing our product. Before its use, please read these instructions carefully. Here you find the most appropriate ways of dealing with this device, the basic principles of safety and maintenance. Please, also keep the user manual so that you can read it during later use.

### **Attention!**

**The manufacturer is not liable for any damage caused by improper use of the device which differ from its intended purpose, or improper handling, as well as a fault of driver resulting from improper use.**

**Contents:**

- 1 PRELIMINARY INFORMATION.....4**
- 2 APPLICATION OF THE DEVICE.....5**
- 3 WARRANTY AND LIABILITY OF THE MANUFACTURER.....5**
- 4 SAFETY GUIDELINES.....6**
  - 4.1 STORAGE, WORK AND TRANSPORT CONDITIONS.....6
  - 4.2 INSTALLATION AND USE OF THE DEVICE.....6
  - 4.3 DECOMMISSIONING OF THE DEVICE.....6
- 5 CONSTRUCTION OF THE DEVICE.....7**
  - 5.1 NANO RELAY OUTPUT PoE.....7
  - 5.2 NANO RELAY OUTPUT.....9
- 6 CONFIGURATION OF THE DEVICE.....11**
  - 6.1 CHANGING THE DEVICE'S IP ADDRESS BY DISCOVERER APPLICATION.....11
  - 6.2 CHANGING THE PC'S SUBNET ADDRESS, FOR THE DEVICE CONFIGURATION.....12
  - 6.3 SECURITY SETTINGS AND ADMINISTRATION.....14
- 7 THE DEVICE FUNCTIONS.....15**
  - 7.1 OUTPUT CONTROL.....15
  - 7.2 CONFIGURATION OF THE OUTPUT CHANNEL.....15
  - 7.3 DESTINATION CLIENT (M2M).....17
  - 7.4 SNMP CONFIGURATION.....21
  - 7.5 WINDOWS COMMAND LINE SOFTWARE.....22
  - 7.6 LINUX CONTROL PROGRAM.....22
  - 7.7 MODBUS TCP.....23
  - 7.8 COMMUNICATION VIA THE MQTT INVEO PROTOCOL.....24
  - 7.9 CONTROL VIA HTTP PROTOCOL.....25
  - 7.10 DESCRIPTION OF THE COMMUNICATION TCP/UDP PROTOCOL.....27
- 8 COMMUNICATION WITH THE MODULE FROM THE EXTERNAL NETWORK.....28**
- 9 CHECKING THE IP ADDRESS.....28**
- 10 DHCP.....28**
- 11 RESTORING FACTORY DEFAULTS.....29**
- 12 FIRMWARE UPDATE.....29**

## 1 Preliminary information

---

**Before starting work with the device, read The User manual and follow the instructions contained therein!**

Description of visual symbols used in this user manual:



This symbol is responsible for reviewing the appropriate place in the user instructions, warnings and important information. Failure to follow warnings could cause injury or damage to the device



Important information and guidelines



Following this guidelines makes the use of the device easier

**Attention:** The screenshots in this manual can be dissimilar from actual images at the time of the device purchase. Due to continuous development of the devices software, some of the functions may differ from these in the manual. The manufacturer claims no responsibility for any undesirable effects (misunderstanding) caused by changes of the software.

## 2 Application of the device

---

The Nano Relay Output device is used to control one electrical circuit using relay. The relay can be controlled using www website, network protocols (HTTP GET, Modbus TCP, SNMP, MQTT) TCP frame or software supplied by manufacturer.

## 3 Warranty and liability of the manufacturer

---



The manufacturer provides a 2-year warranty on the device. The manufacturer also provides post-warranty service for 10 years from the date of the introducing the device on the market. The warranty covers all defects in material and workmanship.

The manufacturer undertakes to comply with the contract of guarantee, if the following conditions are met:

- all repairs, alterations, extensions and device calibrations are performed by the manufacturer or authorized service,
- supply network installation meets applicable standards in this regard,
- the device is operated in accordance with the recommendations outlined in this manual,
- the device is used as intended.

The manufacturer assumes no responsibility for consequences resulting from improper installation, improper use of the device, not following this manual and the repairs of the device by individuals without permission.



**This device doesn't contain serviceable parts.**

## 4 Safety guidelines

---

The device has been designed and built using modern electronic components, according to the latest trends in the global electronics. In particular, much emphasis was placed on ensuring optimum safety and reliability of control. The device has a housing with a high-quality plastic.

### 4.1 Storage, work and transport conditions

The device has to be stored in enclosed rooms which are free of caustic vapors and substances and also meet the requirements:

- surrounding temperature from  $-30^{\circ}\text{C}$  to  $+60^{\circ}\text{C}$ ,
- humidity from 25 to 90%,
- atmospheric pressure from 700 to 1060hPa.

The device working conditions:

- surrounding temperature from  $-10^{\circ}\text{C}$  to  $+55^{\circ}\text{C}$ ,
- relative humidity from 30% to 75%,
- atmospheric pressure from 700 to 1060hPa.

Recommended transport conditions:

- surrounding temperature from  $-40^{\circ}\text{C}$  to  $+85^{\circ}\text{C}$ ,
- relative humidity from 5% to 95%,
- atmospheric pressure from 700 to 1060hPa.

### 4.2 Installation and use of the device

 **The device should be used following the guidelines shown in next part of the user manual.**

### 4.3 Decommissioning of the device

When it becomes necessary to recycle the device (for instance, to decommission the device from service), please contact the manufacturer or its representative, who are obliged to respond, appropriately, i.e. collecting the device from the user. You can also ask the companies involved in recycling of electrical or computer equipment. Under no circumstances should you place the device along with other waste material.

## 5 Construction of the device

---

### 5.1 Nano Relay Output PoE

#### Technical data:

##### Power supply::

PoE: 33-57V POE IEEE 802.3af  
DC: 10-24VDC (screw terminals 3,5mm)  
Power consumption: max 1,5W

##### Outputs:

1 output:                    Output type: relay NO  
                                  Max current: 1A @ 30VDC  
                                  Engage time: 10ms,  
                                  Disengage time: 5ms,

##### Communication:

1 port Ethernet:        10Mbps  
                                  PoE IEEE 802.3af

##### Housing:

IP Code: 30  
Dimensions:

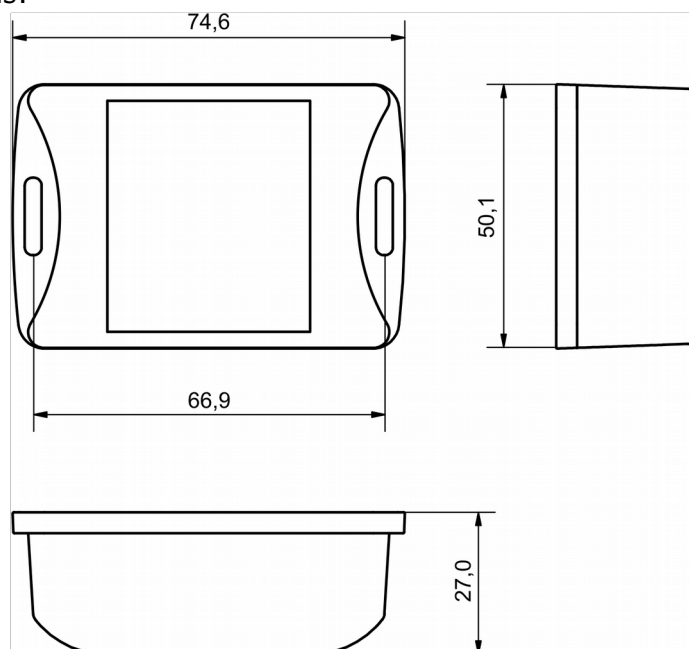

## General features:



The device has a 7-segment display signaling the current input status (**ON** or **OFF**).

There are several ways to communicate with the module:

- using built in WWW server via any web browser,
- Windows / Linux command line programs,
- MODBUS TCP protocol,
- SNMP protocol,
- HTTP protocol,
- MQTT Inveo protocol,
- User application – TCP protocol available for user.

## Description of the module connectors:

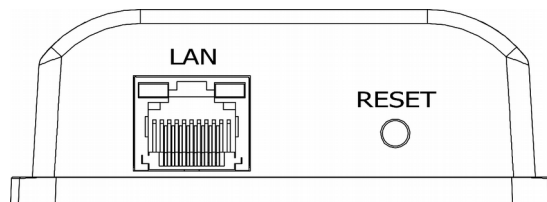

- **LAN** – LAN connection and PoE IEEE 802.3af power supply,
- **RESET** – switch used to enabling DHCP service, checking the current IP address and restoring the module to the factory settings.

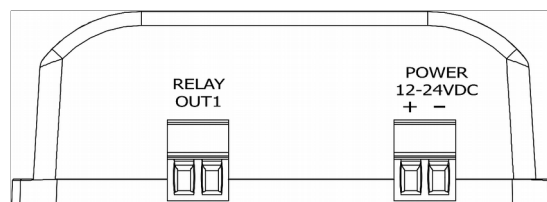

- **OUTPUT** – relay connector NO,
- **POWER** – power connector. An additional power connector used in the event of a PoE power failure. Supply voltage 10-24VDC.



## 5.2 Nano Relay Output

### Technical data:

#### Power supply:

The module is adapted to 12-24VDC power supply.  
Power is supplied through the PoE adapter.

#### Outputs:

1 output:                      Output type: relay NO  
                                     Max current: 1A @ 30VDC  
                                     Engage time: 10ms,  
                                     Disengage time: 5ms,

#### Communication:

1 port Ethernet:              10Mbps  
                                     passive PoE 12-24VDC power supply

#### Housing:

IP Code: 30  
Dimensions:

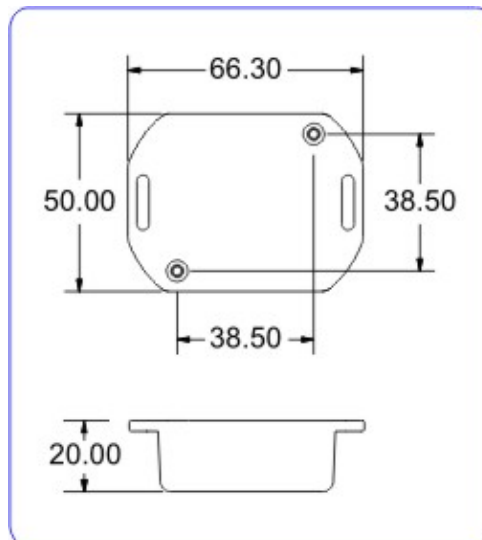

## General features:

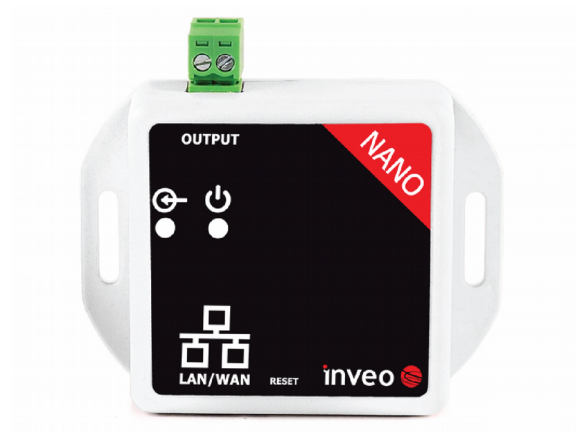

The device has two LEDs. LEDs indicate power supply and input status.

There are several ways to communicate with the module:

- using built in WWW server via any web browser,
- Windows / Linux command line programs,
- MODBUS TCP protocol,
- SNMP protocol,
- HTTP protocol,
- MQTT Inveo protocol,
- User application – TCP protocol available for user.

### Description of the module connectors:

- **LAN** – LAN network and Passive PoE power supply,
- **RESET** – switch used to enabling DHCP service and restoring the module to the factory settings,
- **OUTPUT** – relay connector NO.

## 6 Configuration of the device

The device when used for first time needs to be configured.

There are two methods to do so. The network configuration can be easily changed by Inveo "Discoverer" (<https://inveo.com.pl/software/>) software:

### 6.1 Changing the device's IP address by Discoverer application.

When the "Discoverer" is opened and the relevant device is found, choose Interface list box and click on Change IP button.

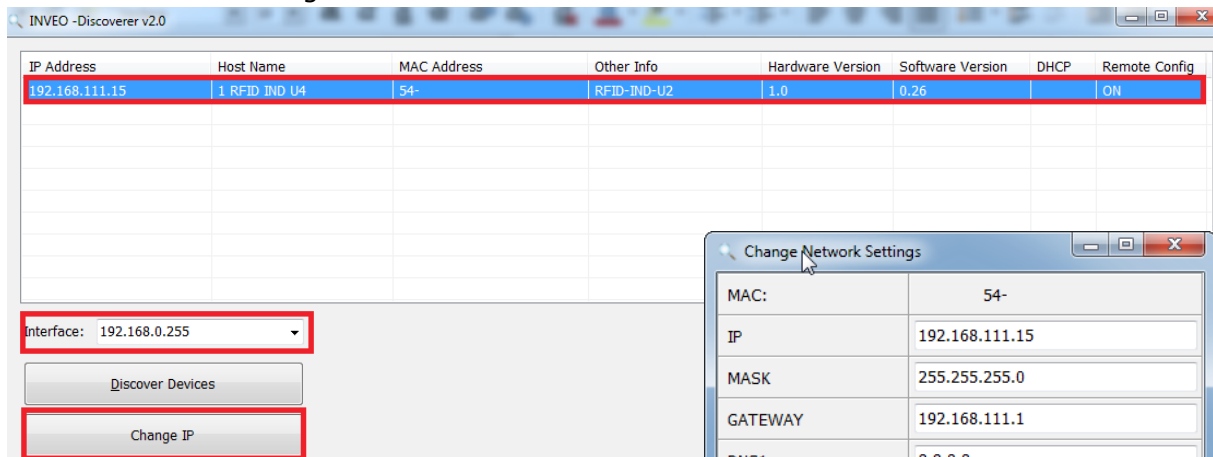

In a new opened dialog box, settings such as IP address, MASK, GATEWAY, DNS1/DNS2 and the Host name can be changed.

Please save correct settings by choosing **Change** button.

If **Remote Config** is disabled (enabled by default), it is necessary to configure the device by changing the computer's subnet (chapter 6.2).

To enable the remote configuration it is necessary to enter **Administration** tab and mark **Enable Remote Network Config**.

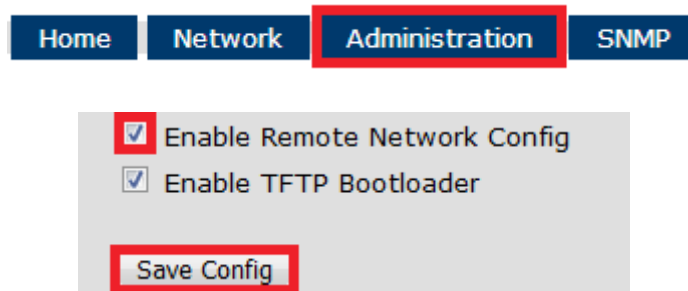

Save the setup by selecting **Save Config** button.

## 6.2 Changing the PC's subnet address, for the device configuration

After the device is connected to a network, a subnet address of a PC which is connected to the same network has to be changed.

To do so, go to the PC's MS Windows network configuration: Start->Control panel ->Network and Sharing Center->Network and Internet->Network Connections, choose the related controller and right click on „Properties“.

After selecting this option configuration window will show up:

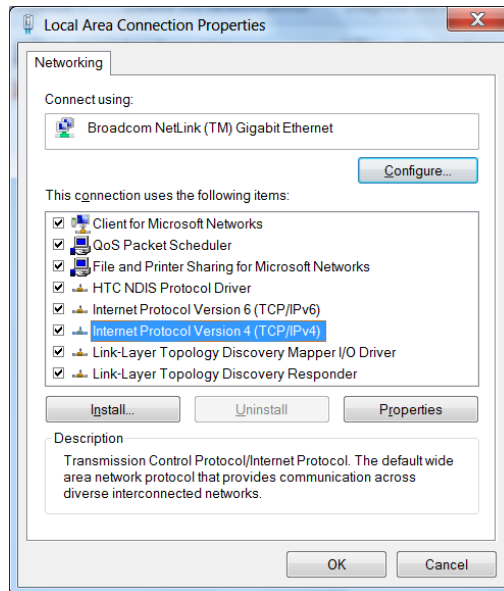

Changing network settings in MS WINDOWS

Next choose "Internet Protocol (TCP/IP)", double click on it and enter following settings:

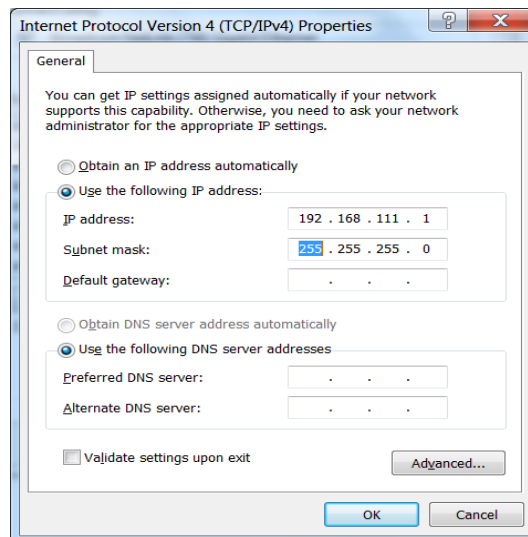

Illustrative TCP/IP protocol settings

After saving changes by clicking OK, open an Internet browser and enter in the browser's address line: **192.168.111.15**.

**Default user name/password:** admin/admin00

In the **Network** tab it is possible to change LAN parameters.

**inveo** Inveo Nano Temperature SV:1.17

Home Channel **Network** SNMP Administration

## Network Configuration

This page allows the configuration of the device's network settings.

MAC Address:	<input type="text"/>
Host Name:	NANO
	<input type="checkbox"/> Enable DHCP
IP Address:	192.168.111.17
Gateway:	192.168.111.1
Subnet Mask:	255.255.255.0
Primary DNS:	8.8.8.8
Secondary DNS:	8.8.4.4
Destination IP:	0.0.0.0
Destination Port:	0
	<input type="button" value="Save Config"/>

To change the network settings, use the following fields:

- **Host Name** – NETBIOS name,
- **DHCP** – checking this box forces use of the address assigned by the DHCP server,
- **IP Address** – the IP address of the reader,
- **Gateway** – network gateway,
- **Subnet Mask** – IP subnet mask,
- **DNS1, DNS2** – DNS servers addresses.
  
- **Destination IP** – the IP address of the server or of the external device in the M2M connection (chapter 7.3),
- **Destination Port** – the listening port of the server or of the external device in the M2M connection.

After all changes, select **Save Config**.

### 6.3 Security settings and administration

The **Administration** settings allow for changing access password and to enable/disable particular services in the device.

**Administration**

This page allows the configuration of the device's access settings.

**Current Password:**

**New Password:**

**Re-type Password:**

Enable Program Access

Enable MODBUS TCP Protocol

Enable SNMP

Enable Destination Client

Enable MQTT Inveo [\[Show Info\]](#)

Enable Remote Network Config

Enable TFTP Bootloader

#### Password change

To change password, in the **Current Password** field write a current password. Next, in the **New Password** field write your new password and confirm it at **Re-type Password** field.

#### Service settings

The device allows to choose which services are to be available. Selecting the check box next to the service name activates the selected service.

**Enable Program Access** – a service of access by a computer program (Windows, Linux) and TCP / IP protocol operating on port 9761,

**Enable MODBUS TCP Protocol** – enables Modbus TCP server,

**Enable SNMP** – enables SNMP protocol supporting,

**Enable Destination Client** – connecting to a remote host service (chapter 7.2),

**Enable MQTT Inveo** – a service that sends data to the INVEO MQTT cloud,

**Enable Remote Network Config** – remote configuration (via the Discoverer application),

**Enable TFTP Bootloader** – enables a bootloader.

#### Attention:

**TFTP Bootloader** and **Remote Network Config** ought to be disabled during normal work operation. It should be enabled for a firmware update only.





## 7 The device functions

### 7.1 Output control

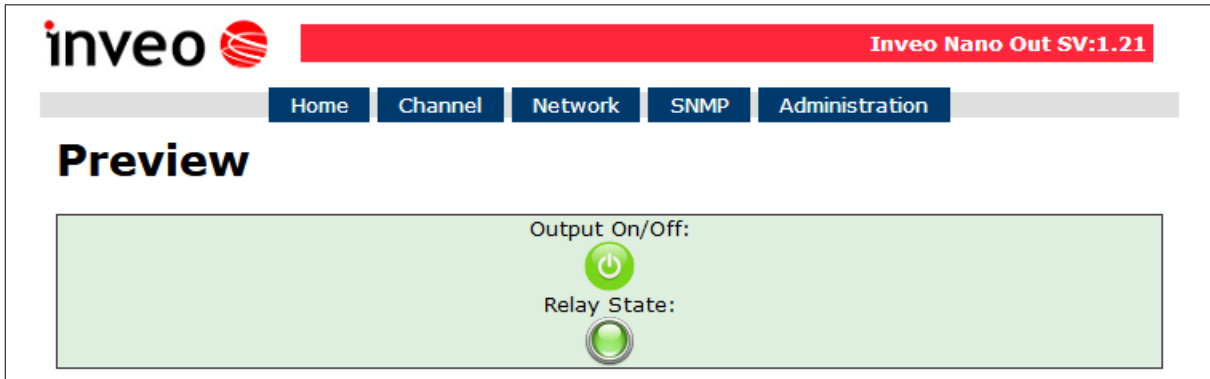
The basic function of the Nano Relay Output module is to control the relay output. The **Home** tab shows the current state of the output channel and the current status of the relay.



Output On/Off: 	Current status of the output channel. The output is switched on or off by clicking on the icon.
Relay State: 	Current state of the relay output.

### 7.2 Configuration of the output channel

The user can configure the output channel settings of the device. Settings can be customized in the **Channel** tab.

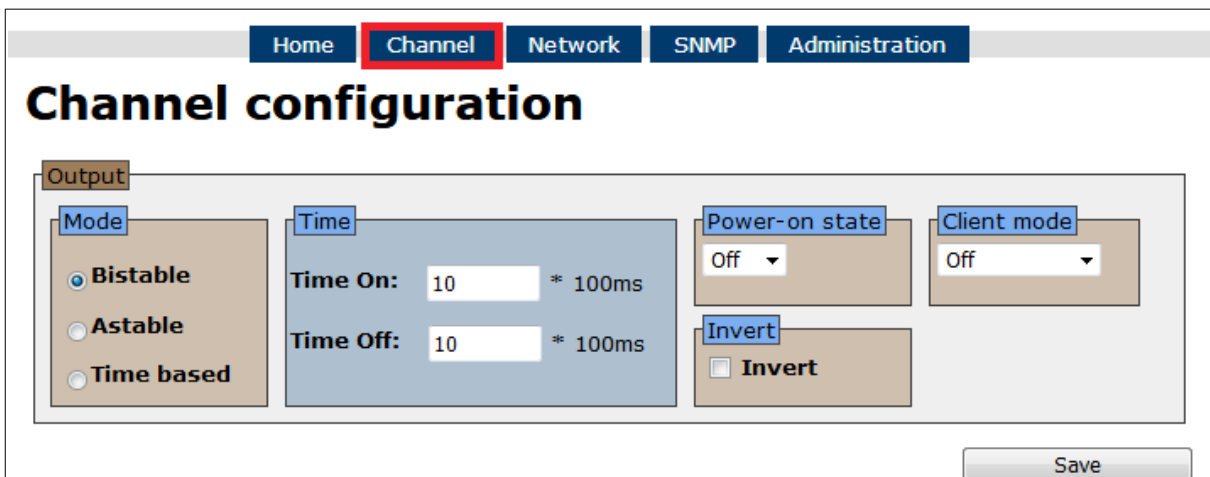

**Power on state** determines the output status after switching on the power supply.

- **ON** – after powering the device, the output channel is active,
- **OFF** – after powering the device, the output channel is inactive,
- **LAST** – after powering the device, the output channel takes the last state before turning off the power.

**Invert** field activates the inversion of the relay contact.

## Output mode

The relay built into the device can work in 3 modes:

- **Bistable** mode – a relay has one determined status (is engaged or disengaged),
- **Astable** mode – if the channel will be enabled, the relay is engage and disengage cyclically. Time of engage and disengage relay:
  - **Time On** – time when a relay is engaged,
  - **Time Off** – time when a relay is disengaged.

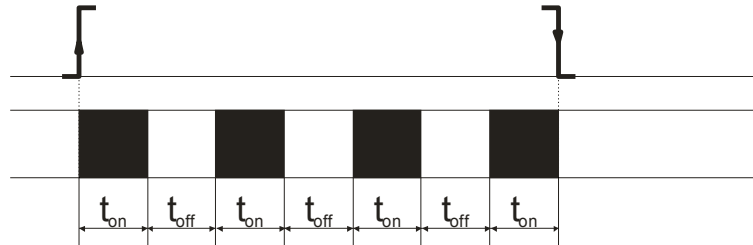

- **TimeBased** mode – one pulse mode.
  - In **TimeBased** mode, if  $t_{on} > 0$  and  $t_{off} > 0$ , after triggering the output, the relay will stay disengaged for  $t_{off}$  and then it will engage for  $t_{on}$ .

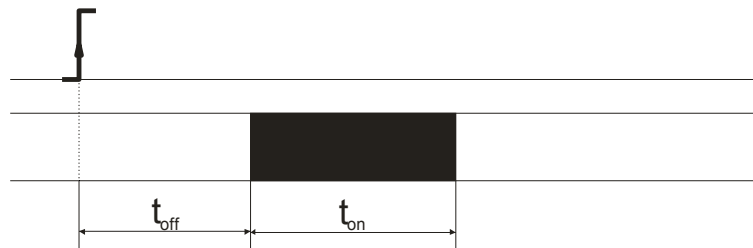

- In **TimeBased** mode, if  $t_{on} > 0$  and  $t_{off} = 0$ , after triggering the output, the relay will engage for  $t_{on}$  and after that it will disengage.



- In **TimeBased** mode, if  $t_{on} = 0$  and  $t_{off} > 0$ , after triggering the output, the relay will stay disengaged for  $t_{off}$  and then it will engage.





### 7.3 Destination Client (M2M)

**Inveo devices as** LanTick, Nano Temperature Sensor, Nano Digital Input, Nano Relay Output or others **are able to send information data to the server or to another module with outputs** using the TCP or UDP protocol. It means that this another module can react to activation of channel or when alarm occurs (Nano Sensors). The message is sent each time state is changed and additionally every 5 seconds.

#### Configuration of devices receiving messages (external devices)

To enable the service, enter the **Administration** tab and select **Enable Program Access** and confirm with the **Save Config** button.

#### Configuration of devices sending alarm status messages

To enable the service, enter the **Administration** tab and select **Enable Destination Client** and confirm with the **Save Config** button.

Home Channel Network SNMP **Administration**

## Administration

This page allows the configuration of the device's access settings.

Current Password:

New Password:

Re-type Password:

Enable Program Access

Enable MODBUS TCP Protocol

Enable SNMP

**Enable Destination Client**

Enable MQTT Inveo [\[Show Info\]](#)

Enable Remote Network Config

Enable TFTP Bootloader

**Save Config**

In the **Network** tab, fill in the **Destination IP** and **Destination Port** fields. The **Destination IP** field is an IP address of the external device or server. The **Destination Port** field is a port number of the external device (9731 by default).

**Destination IP:**

**Destination Port:**

Save Config

Then, in the **Channel** tab select the appropriate output which will be enabled in the external device or – select type of the message.

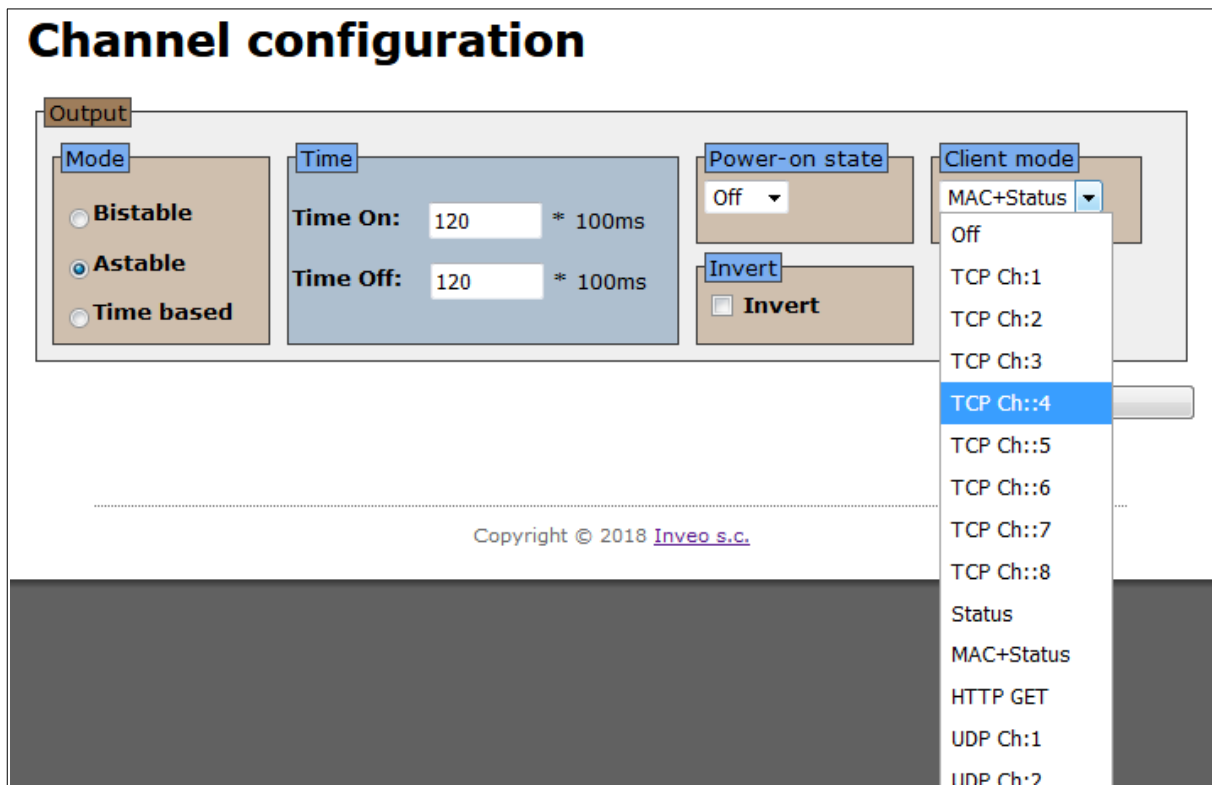

The user can choose the following fields:

- **TCP Ch:x** – the function uses **the connection protocol** i.e. the TCP protocol. Number **Ch:x** is selected output channel in an external device, e.g. LanTick, which will be enabled when the channel state of the local device changes. The TCP frame sends in the **format #1**,
- **UDP Ch:x** – the function uses **the connectionless protocol** i.e. the UDP protocol. Number **Ch:x** is selected output channel in an external device, e.g. LanTick, which will be enabled when the channel state of the local device changes. The UDP frame sends in the **format #1**,
- **Status** – sends the device channel status, TCP frame sent in the **format #2**,
- **MAC+Status** – sends the MAC address of the device and current channel status, TCP frame sent in the **format #3**,
- **HTTP GET** – sends the MAC address of the device and current channel status, frame sent in the **format #4**.

## Frame formats:

### Format #1

The frame in the #1 is sent in binary form.

Active output and set **Ch:5**

SOF	CMD	CH	F_ID	OUT	!OUT	R1	R2	R3	R4	CRC
0x0F	0x01	<b>0x04</b>	0xFF	<b>0x01</b>	0xFE	0x00	0x00	0x00	0x00	0x7F

Inactive output and set **Ch:5**

SOF	CMD	CH	F_ID	OUT	!OUT	R1	R2	R3	R4	CRC
0x0F	0x01	<b>0x04</b>	0xFF	<b>0x00</b>	0xFF	0x00	0x00	0x00	0x00	0x7F

CRC:

$$\text{CRC} = (\text{SOF} + \text{CMD} + \text{CH} + \text{F\_ID} + \text{OUT} + \text{!OUT} + \text{R1} + \text{R2} + \text{R3} + \text{R4}) \text{ MOD } 256$$

### Format #2

The frame in the #2 format is sent as a string.

<Output state>

- **Output state** – value 1 means active output, 0 means inactive output

HEX value	STRING
30	0

### Format #3

The frame in the #3 format is sent as a string.

<MAC>[SPACJA]<Output state>

- **MAC** – MAC address
- **Output state** – value 1 means active output, 0 means inactive output

HEX value														STRING
35	34	31	30	45	43	36	35	35	30	32	31	20	30	5410EC655021 0

#### Format #4

Setting Client Mode to **HTTP GET** causes that the device sends data to the server in the form:

nano.php?mac=<MAC>&io=<Output state>

- **MAC** – MAC address
- **Output state** – value 1 means active output, 0 means inactive output

An example of a frame received by the server:

GET /nano.php?mac=**123456789012**&io=**1**

address MAC = 123456789012,  
io=1,                      the output is enabled

**The TCP frame can be handled with your own software.**

An example of using the netcat command for Linux:

Format #1

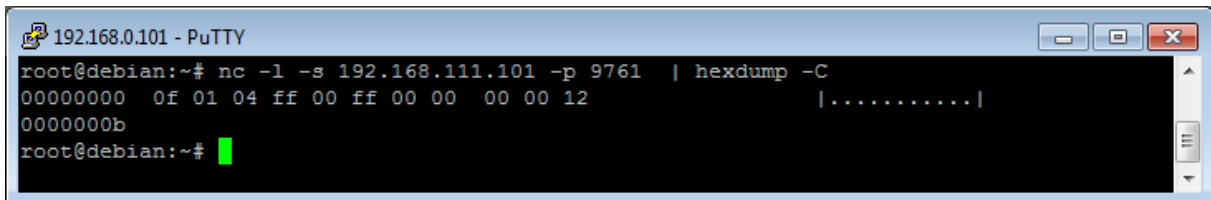

```
192.168.0.101 - PuTTY
root@debian:~# nc -l -s 192.168.111.101 -p 9761 | hexdump -C
00000000  0f 01 04 ff 00 ff 00 00  00 00 12                |.....|
0000000b
root@debian:~#
```

Format #2

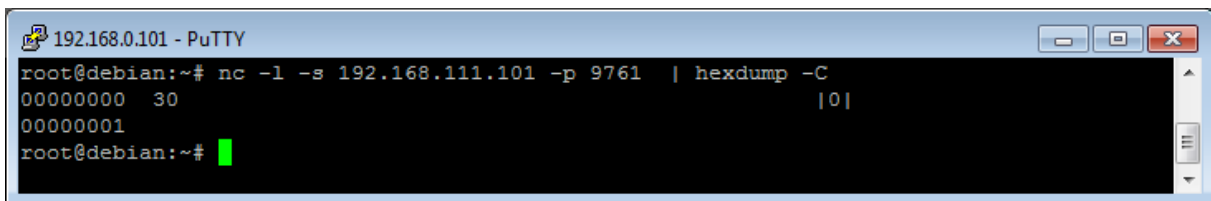

```
192.168.0.101 - PuTTY
root@debian:~# nc -l -s 192.168.111.101 -p 9761 | hexdump -C
00000000  30                                |0|
00000001
root@debian:~#
```

Format #3

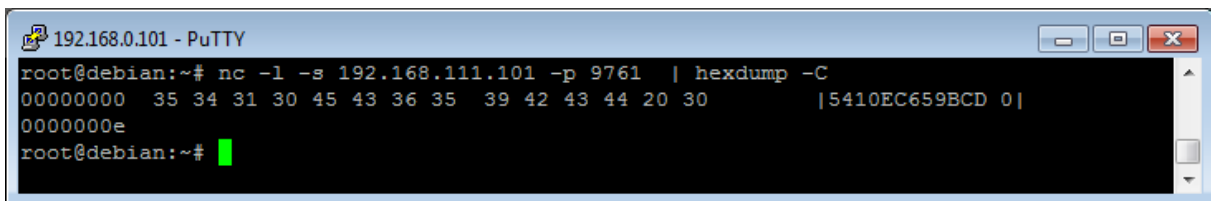

```
192.168.0.101 - PuTTY
root@debian:~# nc -l -s 192.168.111.101 -p 9761 | hexdump -C
00000000  35 34 31 30 45 43 36 35  39 42 43 44 20 30      |5410EC659BCD 0|
0000000e
root@debian:~#
```

## 7.4 SNMP configuration

The module is equipped with an SNMP v2c server.

To enable this feature go to **Administration** tab and check **Enable SNMP** option.

The SNMP protocol allows to read the current value.

The MIB file describing the structure can be downloaded the **SNMP** tab.

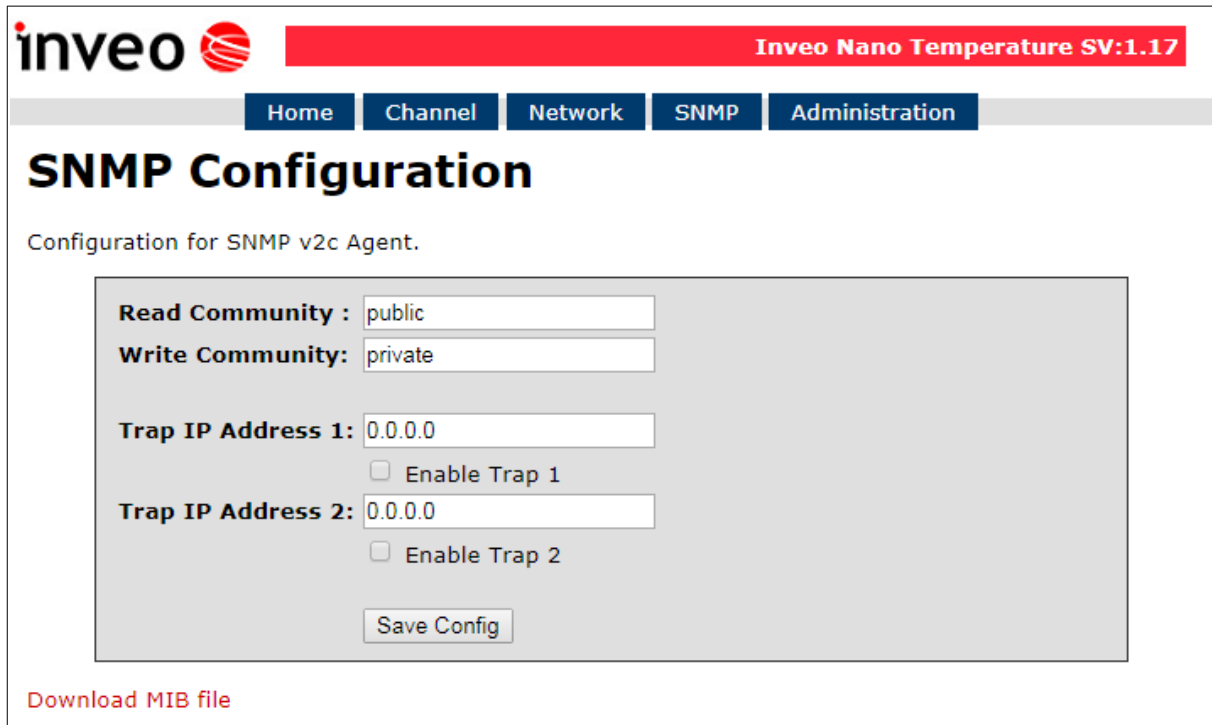

**inveo** Inveo Nano Temperature SV:1.17

Home Channel Network **SNMP** Administration

## SNMP Configuration

Configuration for SNMP v2c Agent.

**Read Community :** public

**Write Community:** private

**Trap IP Address 1:** 0.0.0.0  
 Enable Trap 1

**Trap IP Address 2:** 0.0.0.0  
 Enable Trap 2

Save Config

[Download MIB file](#)

To use the SNMP protocol, save the MIB file by right-clicking on the **Download MIB file** link. Then select the **Save link as** option. Download the file to the MIB Browser program.

The basic parameters that can be read from the Nano Relay Output module can be found in the table:

Name	Format	OID
State of the input channel	INTEGER	.1.3.6.1.4.1.42814.14.3.1.1.0
State of the counter	INTEGER	.1.3.6.1.4.1.42814.14.3.2.1.0

Module can send TRAP messages when the input channel is changed. Destination address should be entered in **Trap IP Address 1** and **Trap IP Address 2** fields.

### 7.5 Windows command line software

The input state can be check by Windows command line.

To use the Windows command line, enable the **Program Access** service in the **Administration** tab.

Windows syntax:

TCPRel.exe [Parameters]

Parameter	Description
<b>-out=1</b>	Output number
<b>-host=[HOST]</b>	Module IP address
<b>-port=[PORT]</b>	Module Port number
<b>-on   -off</b>	Enable / disable the output
<b>-verb</b>	Enabled display of additional info
<b>-stat</b>	Displays current state of outputs

#### Example:

Enable relay, IP address 192.168.111.15, listening on port 9761:

```
TCPRel -out=1 -host=192.168.111.15 -port=9761 -on
```

### 7.6 Linux control program

The output state can be checked by Linux command line.

To use the Linux control program, enable the **Program Access** service in the **Administration** tab.

Syntax is as follows:

./TcpRel.exe [Parameters]

Parameter	Description
<b>-o 1</b>	Output number
<b>-h [HOST]</b>	Module IP address
<b>-p [PORT]</b>	Module Port number
<b>-s [0,1]</b>	Enable / disable the output
<b>-l</b>	Display current output state

#### Examples:

Enable relay, IP address 192.168.111.15, listening on port 9761:

```
./tcprel -o 1 -h 192.168.111.15 -p 9761 -s
```

Checking output state:

```
./tcprel -h 192.168.111.15 -p 9761 -l
```

## 7.7 Modbus TCP

Modbus TCP protocol is listening on port 502.

To enable the Modbus TCP protocol, check the **Enable Modbus TCP** field in the **Administration** tab.

### Supported Modbus functions

The device supports the following MODBUS functions:

- 0x01 Read Coils,
- 0x03 Read Holding Register,
- 0x05 Write Single Coil,
- 0x06 Write Single Register,
- 0x0F Write Multiple Coils,
- 0x10 Write Multiple Registers.

### MODBUS TCP – Coils

Address	Name	R/W	Description
1000	On1	R/W	Enable / disable the relay

### MODBUS TCP – Holding Registers

Address	Name	R/W	Description
4000	T1On	R/W	Relay engage time (*100ms)
4001	T1Off	R/W	Relay disengage time (*100ms)
4002	Rel1Mode	R/W	Mode of operation: 1 – Bistable 2 – Astable 3 – Time Base

### 7.8 Communication via the MQTT Inveo protocol

If the MQTT Inveo service has been enabled in the **Administration** tab, the module sends to mqtt.inveo.com.pl server the value of measured value every 1 minute and additionally at each change.

#### Application configuration – MQTT client:

Address: mqtt.inveo.com.pl

Port: 1883

User name: nanouser

User password: nanouser

Topic: /nanoO/<MAC>

After click [\[Show Info\]](#) the settings for the MQTT client will be displayed:



There are many applications on Android, IOS or PC that can display data sent by the module.



## 7.9 Control via HTTP protocol

Nano modules can be controlled using HTTP GET.

To read the current state of the module, you can refer to the resource in the web browser: <http://192.168.111.15/status.xml>

XML file consist all of the information:

```
<response>
  <prod_name>Nano-1-0</prod_name>
  <sv>1.21</sv>
  <mac>00:00:00:00:00:00</mac>
  <out>00000001</out>
  <on>00000001</on>
  <in>00000000</in>
  <counter1>0</counter1>
  <temp1>0.0</temp1>
</response>
```

Section	Description
<prod_name>Nano-1-0</prod_name>	Module type
<sv>1.17</sv>	The software version of the module
<mac>00:00:00:00:00:00</mac>	MAC address of the module
<out>00000001</out>	Relay state
<on>00000001</on>	Output state
<in>00000000</in>	In the Nano Relay Output module always 0
<counter1>0</counter1>	In the Nano Relay Output module always 0
<temp1>0.0</temp1>	In the Nano Relay Output module always 0

HTTP GET command	Description
<a href="http://nr_ip/stat.php?on=1">http://nr_ip/stat.php?on=1</a>	Enable output relay
<a href="http://nr_ip/stat.php?off=1">http://nr_ip/stat.php?off=1</a>	Disable output relay
<a href="http://nr_ip/stat.php?inv=1">http://nr_ip/stat.php?inv=1</a>	Invert output state
<a href="http://nr_ip/stat.php?set=0000000x">http://nr_ip/stat.php?set=0000000x</a>	Set output Available options x=: 1 – enable 0 – disable n – invert - - no changes

Examples of module control using the HTTP GET protocol:

1. Enable relay output:

<http://192.168.111.15/stat.php?on=1>

2. Invert output relay state:

<http://192.168.111.15/stat.php?inv=1>

3. Disable relay output:

<http://192.168.111.15/stat.php?off=1>

## Example of reading data with the command CURL.

Warning:

Access to the **stat.php** resources require authorization.

Access to the **status.xml** resources does not require authorization.

### Reading the relay status:

```
curl -u admin:admin00 "http://192.168.111.15/stat.php" -w "\n" 2>/dev/null | grep 'out' | awk -F "[><]" '/out/{print $3}' | cut -c8
```

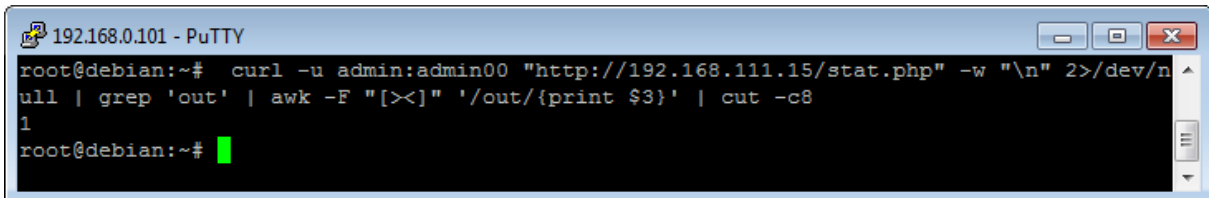

```
192.168.0.101 - PuTTY
root@debian:~# curl -u admin:admin00 "http://192.168.111.15/stat.php" -w "\n" 2>/dev/n
ull | grep 'out' | awk -F "[><]" '/out/{print $3}' | cut -c8
1
root@debian:~#
```

### Reading the name of the module:

```
curl -u admin:admin00 "http://192.168.111.15/stat.php" -w "\n" 2>/dev/null | grep 'prod_name' | awk -F "[><]" '/prod_name/{print $3}'
```

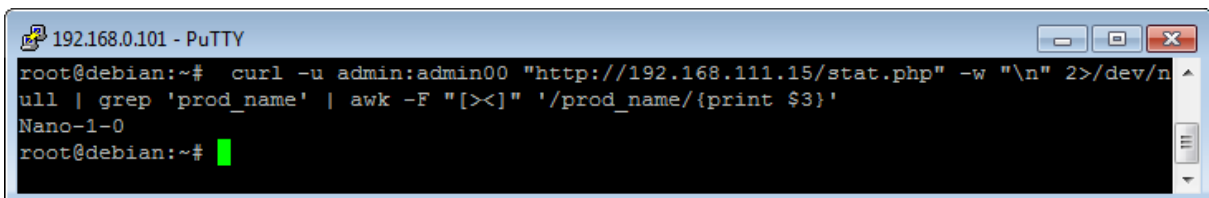

```
192.168.0.101 - PuTTY
root@debian:~# curl -u admin:admin00 "http://192.168.111.15/stat.php" -w "\n" 2>/dev/n
ull | grep 'prod_name' | awk -F "[><]" '/prod_name/{print $3}'
Nano-1-0
root@debian:~#
```

### Switching on / off the output channel:

```
curl -u admin:admin00 "http://192.168.111.15/stat.php?on=1"
```

```
curl -u admin:admin00 "http://192.168.111.15/stat.php?off=1"
```

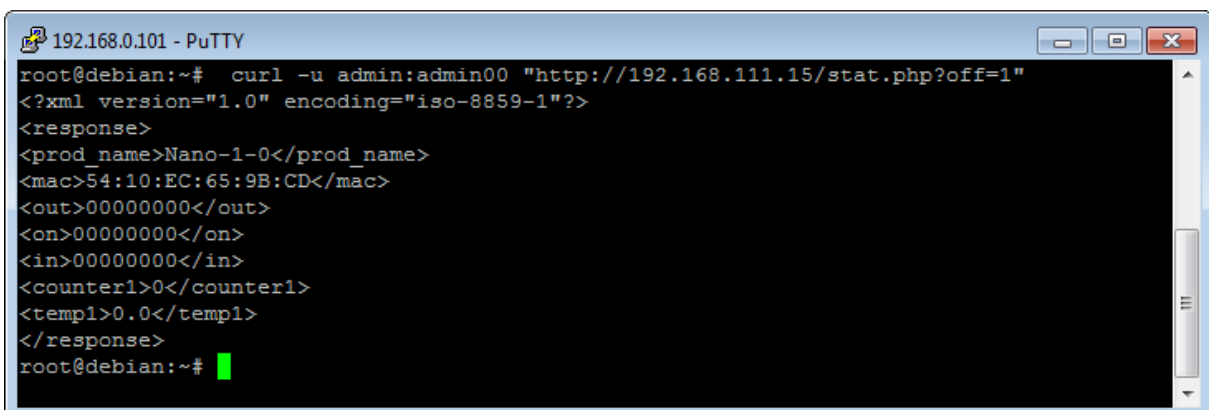

```
192.168.0.101 - PuTTY
root@debian:~# curl -u admin:admin00 "http://192.168.111.15/stat.php?off=1"
<?xml version="1.0" encoding="iso-8859-1"?>
<response>
<prod_name>Nano-1-0</prod_name>
<mac>54:10:EC:65:9B:CD</mac>
<out>00000000</out>
<on>00000000</on>
<in>00000000</in>
<counter1>0</counter1>
<temp1>0.0</temp1>
</response>
root@debian:~#
```

## 7.10 Description of the communication TCP/UDP protocol

Frame for the TCP / UDP port 9761.

Command	Nr bajtu	1	2	3	4	5	6	7	8	9	10	11	
	Nazwa bajtu	SOF	CMD	Channel	Data1	Data2	Data3	Data4	Data5	Data6	Data7	CRC	Return
Output control	dec	15	1	0-7	Mode [1-3]*	On/Off [0,1]	TON LSB	TON MSB	TOFF LSB	TOFF MSB	Power on state [0-2]	CRC	OK
	hex	0x0F	0x01	0x00	Mode [1-3]*	0-1	TON LSB	TON MSB	TOFF LSB	TOFF MSB	[0-2]	CRC	OK
Downloading channel parameters	dec	15	2	0-7	x	x	x	x	x	x	x	CRC	
	hex	0x0F	0x02	0-7	x	x	x	x	x	x	x	CRC	
Writing to the EPROM memory	dec	15	20	0	10	0	0	0	0	0	11	CRC	OK
	hex	0x0F	0x14	0x00	0x0A	0x00	0x00	0x00	0x00	0x00	0x0B	0x38	OK
Read channels state	dec	15	100	x	x	x	x	x	x	x	x	115	CH7-CH0**
	hex	0x0F	0x64	x	x	x	x	x	x	x	x	0x73	CH7-CH0**
Read device name	dec	15	200	x	x	x	x	x	x	x	x	215	String
	hex	0x0F	0xC8	x	x	x	x	x	x	x	x	0xD7	String

\*\* Chx returns 2 bytes:

- 1 – output state,
- 2 – coil state.

Description	Value	State
On/Off	0	Off
	1	On
*Mode	1	Bistable
	2	Astable
	3	Time based
CRC	The sum of bytes	

Set the output to astable mode with time Ton = Toff = 1.7 seconds.

	SOF	CMD	CH	D1	D2	D3	D4	D5	D6	D7	CRC
dec	15	1	0	2	1	17	0	17	0	0	53
hex	0x0F	0x01	0x00	0x02	0x01	0x11	0x00	0x11	0x00	0x00	0x35

Save settings to the EPROM memory.

dec	15	1	0	2	1	17	0	17	0	0	53
hex	0x0F	0x01	0x00	0x02	0x01	0x11	0x00	0x11	0x00	0x00	0x35

## **8 Communication with the module from the external network**

---

If the module is in a different LAN network than the computer connecting to it, port forwarding is required.

Depending on the communication method used with the module, it is necessary to contact the Network Administrator and port forwarding:

### **Support via website and HTTP protocol:**

- port TCP 80

### **Service by a computer program or by your own application:**

- port TCP 9761

### **Support via MODBUS TCP:**

- port TCP 502

### **Support via SNMP protocol:**

- port UDP 161

## **9 Checking the IP address**

---

To check the current IP address of the device (Nano Relay Output PoE only):

1. Press and hold the reset button until the display shows the four parts of the IP number, e.g. **192 168 111 15**.
2. Release the reset button.

## **10 DHCP**

---

To enable/disable DHCP service:

1. Press and hold RESET button 5 to 10 second.
2. Green LED will start flashing 2 times a second (Nano Relay Output), the display will show: **dhcP** (Nano Relay Output PoE).
3. Zwolnić przycisk RESET.

It is also possible to enable DHCP in the network configuration in the **Network** tab or through **Discoverer** application.

## 11 Restoring factory defaults

---

To reset the device to factory settings:

1. Press and hold RESET button for 10 to 15 seconds
2. Green LED will start flashing 2 times a second (Nano Relay Output), the display will show: **rSt** (Nano Relay Output PoE).
3. Release the reset button.

With factory defaults restored the module settings are as follows:

- DHCP: enabled
- IP address: 192.168.111.15
- IP mask: 255.255.255.0
- User name: admin
- Password: admin00

## 12 Firmware update

---

The device has the ability to update the firmware. The software update program is provided as a \*.bin file.

**Warning!** Incorrect use of the update feature may damage the reader. Make sure that undisturbed power is provided to the device for duration of programming.

To update the software:

- check the **Enable TFTP Bootloader** option, which is located in the Administration tab,
- run the Windows command line (Start-> Run enter 'cmd' and confirm with the Enter key),
- go to the directory where the .bin file is located
- enter the command:

```
tftp -i <address_ip_of the reader> PUT file.bin
```

where: <address\_ip\_of the reader> is the IP Address of the reader  
file.bin – the file with the update program

Programming takes 1-2 minutes. End of programming confirms the message 'File Transferred'.

For correct functioning of the reader, after the update operation the „**Enable TFTP Bootloader**” option has to be switched off.

Step-by-step instruction for firmware updates is available at <https://inveo.com.pl>.

**The latest instructions and software are available on the site <https://inveo.com.pl>.**